



ADLINK
TECHNOLOGY INC.

MXC-2300

Intel® Atom™ E3845 Quad-Core Processor-Based
Fanless Expandable Embedded Computer
with PCI/PCIe Slots



Manual Rev.: 2.00

Revision Date: Oct. 8 2015

Part No: 50-1Z159-1000

Advance Technologies; Automate the World.

Revision History

Revision	Release Date	Description of Change(s)
2.00	Oct. 8, 2015	Initial Release

Preface

Copyright 2015 ADLINK Technology, Inc.

This document contains proprietary information protected by copyright. All rights are reserved. No part of this manual may be reproduced by any mechanical, electronic, or other means in any form without prior written permission of the manufacturer.

Disclaimer

The information in this document is subject to change without prior notice in order to improve reliability, design, and function and does not represent a commitment on the part of the manufacturer.

In no event will the manufacturer be liable for direct, indirect, special, incidental, or consequential damages arising out of the use or inability to use the product or documentation, even if advised of the possibility of such damages.

Environmental Responsibility

ADLINK is committed to fulfill its social responsibility to global environmental preservation through compliance with the European Union's Restriction of Hazardous Substances (RoHS) directive and Waste Electrical and Electronic Equipment (WEEE) directive. Environmental protection is a top priority for ADLINK. We have enforced measures to ensure that our products, manufacturing processes, components, and raw materials have as little impact on the environment as possible. When products are at their end of life, our customers are encouraged to dispose of them in accordance with the product disposal and/or recovery programs prescribed by their nation or company.

Trademarks

Product names mentioned herein are used for identification purposes only and may be trademarks and/or registered trademarks of their respective companies.

Conventions

Take note of the following conventions used throughout this manual to make sure that users perform certain tasks and instructions properly.



NOTE:

Additional information, aids, and tips that help users perform tasks.



Information to prevent **minor** physical injury, component damage, data loss, and/or program corruption when trying to complete a task.



Information to prevent **serious** physical injury, component damage, data loss, and/or program corruption when trying to complete a specific task.

Table of Contents

Revision History	ii
Preface	iii
List of Tables	xi
List of Figures	xiii
1 Introduction	1
1.1 Overview	1
1.2 Features.....	2
1.3 Specifications.....	3
1.4 Schematics and Dimensions	6
1.5 Front Panel I/O Connectors	10
1.5.1 Power Button	11
1.5.2 LED Indicators	12
1.5.3 Reset Button.....	12
1.6 Digital I/O Connector	12
16-CH Isolated DI	12
16-CH Isolated DO	12
Isolated 5V DC Power Source for DO	13
General Specification	13
1.6.1 Isolated Digital Input Circuits	15
1.6.2 Isolated Digital Output Circuits	18
1.6.3 Digital I/O Windows Driver and API.....	18
1.6.4 Controller Area Network (CAN) Port.....	19
1.6.5 USB 2.0 Ports.....	20
1.6.6 USB 3.0 Ports.....	20
1.6.7 Gigabit Ethernet Ports	20
1.6.8 Compact Flash Socket	21
1.6.9 DVI-I Connector	22

1.6.10	COM Port Connectors	23
1.6.11	DisplayPort Connectors	23
1.6.12	Audio Jacks	25
1.6.13	DC Power Connector	26
1.6.14	PCI Slot	26
1.6.15	PCI Express x4 Slot.....	27
1.7	Internal I/O connectors.....	27
1.7.1	Clear CMOS Jumper	29
1.7.2	Internal Reserved +5V and +12V Connector.....	29
1.7.3	12V DC Fan Connector	30
1.7.4	Internal USB Connector.....	30
1.7.5	SATA Connectors	30
1.7.6	Backboard to System PCB Connector.....	31
2	Getting Started	33
2.1	Unpacking Checklist	33
2.2	Installing Hard Disk Drives.....	34
2.3	Installing a PCI/PCIe Card	39
2.4	Installing a mini-PCI-E device	41
2.5	Installing CF Cards	44
2.6	Connecting DC Power	47
2.7	Wall-mounting the MXC-2300.....	47
2.8	Optional Fan Module.....	51
2.9	Cooling Considerations.....	52
3	Driver Installation.....	53
3.1	Installing the Chipset Driver	54
3.2	Installing the Graphics Driver.....	54
3.3	Installing the Ethernet Driver.....	55
3.4	Installing the Audio Driver	55
3.5	Installing the USB 3.0 Driver.....	56
3.6	Installing the Intel Management Engine Driver	56

3.7	Installing the WDT Driver/API	56
3.8	Installing the DI/O Driver/API	57
A	Appendix: Power Supply & Consumption	59
A.1	Power Consumption Reference	59
A.2	Power Supply Reference	60
A.3	Accessory Cabling	60
B	Appendix: BIOS Setup	61
B.1	Main	61
	62
	BIOS Information	62
	System Time/System Date	62
B.2	Advanced.....	63
B.2.1	CPU Configuration.....	64
	Limit CPUID Maximum	64
	Execute Disable Bit	64
	Hardware Prefetcher	64
	Adjacent Cache Line Prefetch	65
	Intel Virtualization Technology	65
B.2.2	Memory Configuration	65
B.2.3	Onboard Device Configuration	66
	COM1 Control	66
	COM2 Control	66
	LAN #1 (Intel I210)	66
	LAN #1(I210) Launch PXE OpROM	66
	LAN #2 (Intel I210)	67
	LAN #2(I210) Launch PXE OpROM	67
	SATA Controller(s)	67
	Legacy USB Support	67
	XHCI Legacy Support	67
	XHCI Hand-off	67

	EHCI Hand-off	68
	USB Mass Storage Driver Support	68
	USB transfer time-out	68
	Device reset time-out	68
	Device power-up delay	68
B.2.4	Advanced Power Management.....	69
	Restore AC Power Loss	69
	Wake System With Fixed Time	70
	Wake On Ring	70
	BIOS POST Watchdog	70
B.2.5	SATA Configuration.....	71
	SATA Mode Selection	71
	SATA Port / CF Card	71
B.2.6	Serial Port Console Redirection.....	72
	COM1/ COM2/ COM3/ COM4 COM	
	Console Redirection	72
	(EMS) Console Redirection	74
B.2.7	CSM Configuration	76
	GateA20 Active	76
	Option ROM Messages	76
	INT19 Trap Response	77
	Boot option filter	77
	Launch Network OpROM policy	77
	Launch Storage OpROM policy	77
	Other PCI device ROM priority	77
B.2.8	System Management (SEMA).....	78
B.3	Chipset.....	79
B.3.1	USB Configuration.....	80
	XHCI Mode	80
	USB 2.0(EHCI) Support	80
B.3.2	High Precision Timer	80
B.3.3	Intel® IGD configuration	81

Integrated Graphics Device	81
IGD Turbo Enable	81
Primary Display	81
GFX Boost	81
DVMT Pre-Allocated	81
DVMT Total Gfx Mem	81
Aperture Size	82
B.4 Security.....	82
B.4.1 Administrator Password.....	82
B.4.2 User Password	82
B.4.3 BIOS Read/Write Protection.....	83
B.5 Boot	83
B.5.1 Boot Configuration.....	83
Setup Prompt Timeout	83
Bootup NumLock State	83
Quiet Boot	84
Fast Boot	84
B.5.2 Boot Option Priorities.....	84
Boot Option #	84
B.5.3 Hard Drive BBS Priorities	84
B.6 Save & Exit	85

C Appendix: Watchdog Timer (WDT)

Function Library.....	87
C.1 WDT with API/Windows.....	87
InitWDT	87
SetWDT	87
C.2 WDT with DOS/Linux.....	90

D Appendix: Digital Input/Output

Function Library.....	93
ADMX_DIO_Init	93
ADMX_DIO_Close	93

DI_ReadPort	94
DO_WritePort	94
DO_ReadPort	95
DI_ReadLine	95
DO_WriteLine	96
DO_ReadLine	97
DIO_INT_Event_Message	97
DIO_INT1_EventMessage	99
DIO_INT2_EventMessage	100
DIO_SetDualInterrupt	101
Important Safety Instructions.....	103
Getting Service	105

List of Tables

Table 1-1:	Front Panel I/O Connector Legend.....	11
Table 1-2:	LED Indicators	12
Table 1-3:	Digital I/O Connector Pin Signals	14
Table 1-4:	Digital I/O Connector Pin Legend	15
Table 1-5:	CAN Port Pin Assignments.....	19
Table 1-6:	Active/Link LED	21
Table 1-7:	Speed LED	21
Table 1-8:	DVI-I Connector Signals	22
Table 1-9:	D-Sub 9p Signal Function of Com Ports.....	23
Table 1-10:	DisplayPort Pin Assignments	24
Table 1-11:	Applicable Cable Types.....	24
Table 1-12:	Audio Jack Signals	25
Table 1-13:	DC Power Supply Connector Signals.....	26
Table 1-14:	Mainboard Connector Legend	28
Table 1-15:	Backplane Board Connector Legend.....	28
Table 1-16:	Clear CMOS Jumper Settings	29
Table 1-17:	+5V and +12V Connector Pin Functions	30
Table A-1:	Power Consumption	59
Table A-2:	Power Supply	60

This page intentionally left blank.

List of Figures

Figure 1-1:	MXC-2300 Functional Block Diagram	5
Figure 1-2:	MXC-2300 Left Side View	6
Figure 1-3:	MXC-2300 Front View	7
Figure 1-4:	MXC-2300 Top View	8
Figure 1-5:	MXC-2300 Rear View	8
Figure 1-6:	MXC-2300 Underside View	9
Figure 1-7:	Front Panel I/O Connectors	10
Figure 1-8:	Isolated Digital Input Circuit.....	15
Figure 1-9:	Isolated Digital Input Differential Input Circuit.....	16
Figure 1-10:	Isolated Digital Input Sample Application Circuit	17
Figure 1-11:	Isolated Digital Output Circuits	18
Figure 1-12:	Isolated Digital Output Sample Application Circuit ...	18
Figure 1-13:	CAN Port	19
Figure 1-14:	DisplayPort Connector.....	23
Figure 1-15:	Mainboard PCB	27
Figure 1-16:	Backplane Board PCB.....	28
Figure 1-17:	+5V and +12V Connector Pin Connector	29

This page intentionally left blank.

1 Introduction

1.1 Overview

Featuring the latest Intel® Atom™ E3845 Quad-core processor, the Matrix MXC-2300 series excels with minimal power consumption, exceptional 3D graphics, and powerful media acceleration, delivering leading improvements in performance and cost-efficiency over any previous generation Atom-based system.

Including dual-port CAN connectivity supported by a Phillips SJA1000 controller that can run independently or bridged at the same time, bus arbitration and error detection with auto-correction and re-transmission capability, and 16-CH isolated DI/O for general industrial control, the MXC-2300 features an increased total 3PCI/PCle expansion slot count, supporting installation of a variety of off-the-shelf PCI/PCle cards for configurable applications, and an internal PCI Express Mini Card socket and USIM slot support extension of additional functions, such as wireless connection.

In addition, the MXC-2300series offers one DisplayPort and one DVI-I port for dual independent display with full HD over HDMI, four USB 2.0 and one USB 3.0 ports, and 2 GbE LAN ports with teaming function.

With ADLINK's proprietary SEMA (Smart Embedded Management Agent) tool, the MXC-2300 maximizes manageability and security for a world of applications, providing efficient remote monitoring of system activity and health in real time, system control over a robust secured channel, and fully manageable complete utilization of system resources.

With ruggedized architecture, flexibility, and rich I/O capacity, the MXC-2300's minimal power consumption, abundant features, and leading performance and cost-efficiency make it the embedded system of choice for industrial automation, facility management, and intelligent transportation systems and applications demanding reliability in harsh environments.

1.2 Features

- ▶ Intel® Atom™ E3845 processor with 4C @1.91 GHz SoC
- ▶ 2x DDR3L SO-DIMM, supporting up to 8GB memory
- ▶ 2 PCI + 1 PCIe x4 or 3 PCI expansion slots
- ▶ Built-in dual-port isolated CAN and 16-CH isolated DI and DO
- ▶ 1 DisplayPort + 1 DVI-I
- ▶ 2 Intel GbE ports with teaming function, 1 USB 3.0 + 4 USB 2.0 ports
- ▶ 1 external CF slot and 1 internal PCIe Mini Card socket with USIM socket
- ▶ 2 software-programmable RS-232/422/485 + 2 RS-232 ports
- ▶ Built-in 9 to 32 VDC wide-range DC power input
- ▶ Rugged, -20°C to 70°C fanless operation (w/ industrial SSD)
- ▶ Built-in ADLINK SEMA 1.0 (Smart Embedded Management Agent)



NOTE:

This option guarantees cold boot of the system at -20°C and operation with 100% loading at 60° without add-on cards. The industrial solid-state drive storage option is required.

1.3 Specifications

	MXC-2300CD-3E1	MXC-2300CD-3S	MXC-2300-3E1	MXC-2300-3S
System Core				
Processor	Intel® Atom™ Processor E3845 (Bay Trail-I Premium) 4C @ 1.91GHz CPU			
Chipset	Intel SoC (System on Chip)			
Video	1 DisplayPort +1 DVI-I (VGA or DVI-D) DP: resolution up to 2560x1600 VGA: resolution up to 1600x1200			
Memory	4GB DDR3L 1333MHz SODIMM module, (up to 8GB with 2 SODIMM sockets)			
I/O Interface				
Expansion slots	2 PCI+1 PCIe x4	3 PCI	2 PCI+1 PCIe x4	3 PCI
Ethernet	2 Intel® GbE ports (Intel® Springville WGI210IT chipset) Teaming function, Wake On LAN			
Serial Ports	2 software-programmable RS-232/422/485 (COM 1&2) with auto-flow control, 2 RS-232 (COM 3&4)			
USB	5 external USB ports (4 USB 2.0 + 1 USB 3.0) + 1 internal USB 2.0			
CAN	2 DB9 isolated CAN port with SJA1000 CAN controller	-		
DIO	16-CH DI and 16-CH DO with 1.5KV isolation	-		
Mini PCIe	1 internal mini PCIe card socket	-		
USIM	1 USIM socket for 3G communication	-		
Audio	1 MIC-in and 1 Line-out			

	MXC-2300CD-3E1	MXC-2300CD-3S	MXC-2300-3E1	MXC-2300-3S
Power Supply				
DC Input	Built-in 9-32 V _{DC} wide-range DC input pluggable connectors with latch (GND, V-, V+), 2-pin remote power on/off switch			
AC Input	Optional 100 W external AC-DC adapter for AC input			
Storage				
SATA HDD	Onboard SATA-II port for 2.5" HDD/SSD installation			
CompactFlash	1 CompactFlash socket			
Mechanical				
Optional Fan Module	Optional fan module for heat dissipation, smart fan control			
Dimensions	142 (W) x219 (D) x210(H) mm (WxDxH) (5.84" x 8.76" x 8.4)			
Weight	3.5 kg			
Mounting	Wall-mount kit			
Environmental				
Operating Temperature	Standard: 0°C to 50°C (32°F to 122°F) Extended Temperature: -20°C to 70°C (-4°F to 158°F) (w/industrial SSD or CF)			
Storage Temperature	-40°C to 85°C (-40°F to 185°F) (excl. HDD/SDD/CF)			
Humidity	~95% @ 40°C (104°F) (non-condensing)			
Vibration	Operating, 5 Grms, 5-500 Hz, 3 axes (w/ CF or SSD) Operating, 0.5 Grms, 5-500 Hz, 3 axes (w/ HDD)			
ESD	Contact +/-4 KV and Air +/-8 KV			
Shock	Operating, 50 G, half sine 11 ms duration (w/ CF or SSD)			
EMC	CE and FCC Class A			

	MXC-2300CD-3E1	MXC-2300CD-3S	MXC-2300-3E1	MXC-2300-3S
Safety	UL/cUL UL 60950-1 & CAN/CSA-C22.2 #60950-1, UL report #A48-UL			



NOTE:

Extending operating temperature to the -20°C to +70°C range is optional and requires an industrial solid-state storage drive.

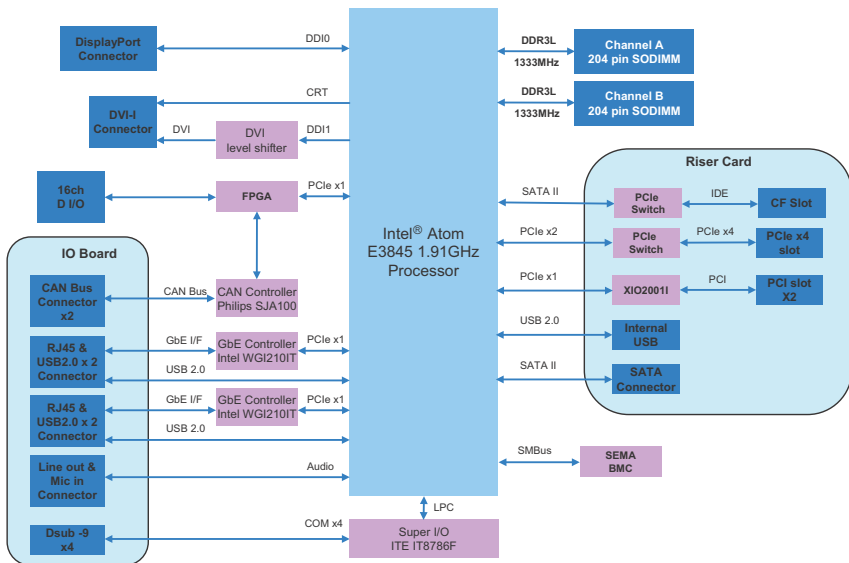

Figure 1-1: MXC-2300 Functional Block Diagram

1.4 Schematics and Dimensions



All dimensions shown are in mm (millimeters).

NOTE:

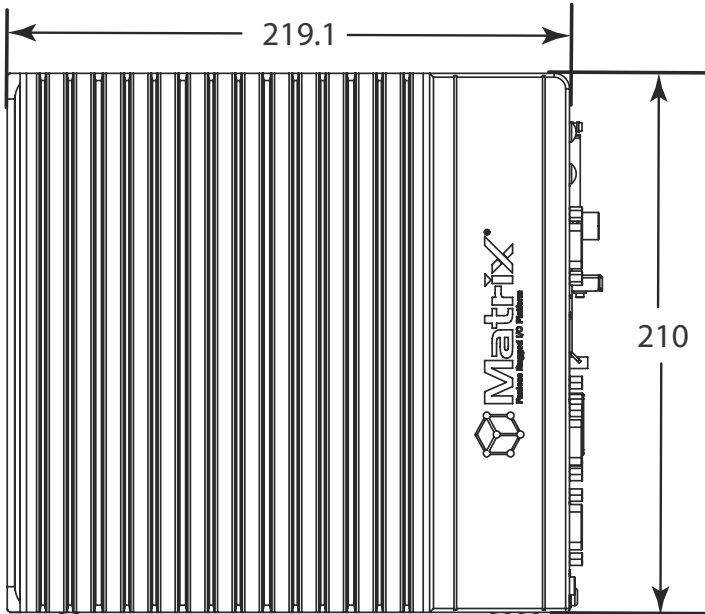

Figure 1-2: MXC-2300 Left Side View

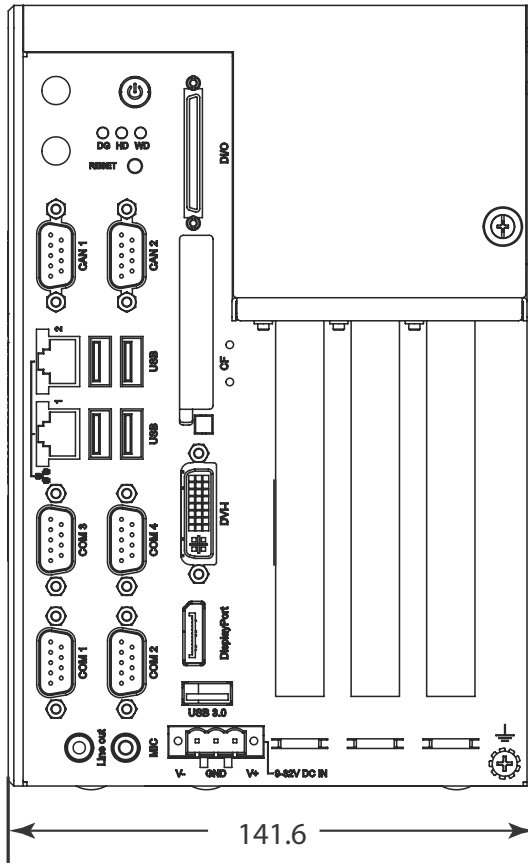

Figure 1-3: MXC-2300 Front View

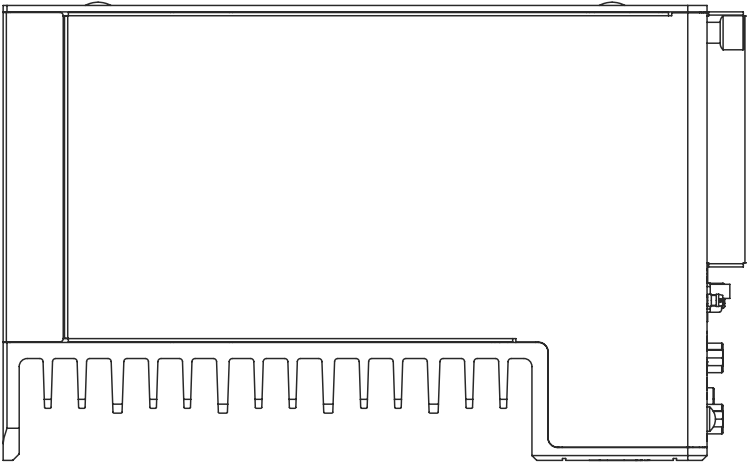

Figure 1-4: MXC-2300 Top View

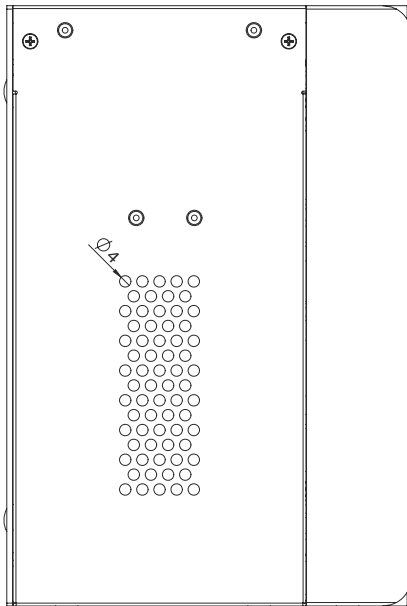

Figure 1-5: MXC-2300 Rear View

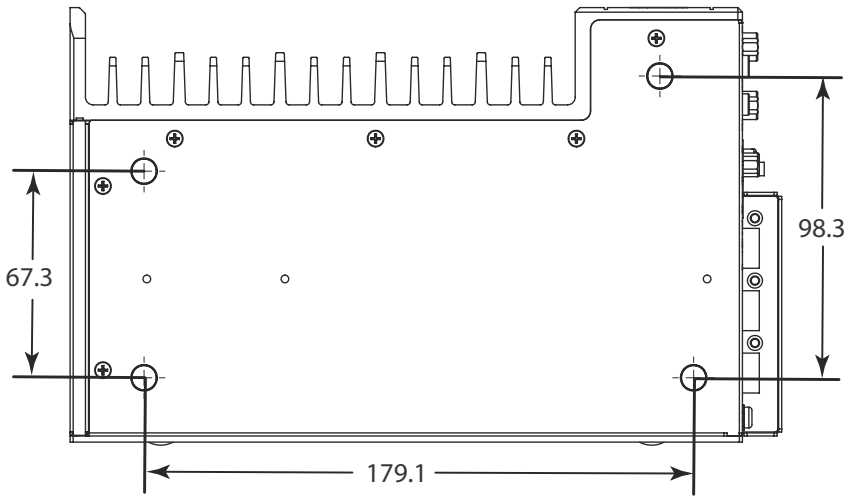

Figure 1-6: MXC-2300 Underside View

1.5 Front Panel I/O Connectors

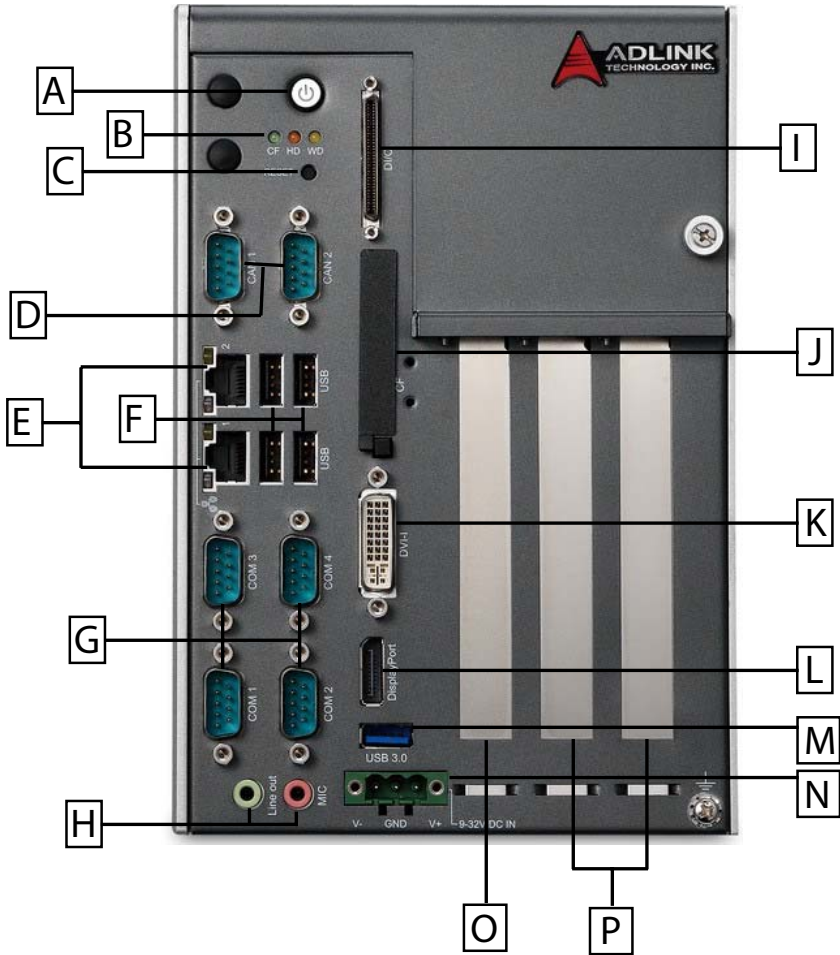

Figure 1-7: Front Panel I/O Connectors

A	Power Button	I	Digital I/O connector
B	LED Indicators	J	Compact-Flash slot
C	Reset Button	K	DVI-I connector
D	DB9 CAN Bus x2	L	DisplayPort connector
E	GbE x2	M	USB3.0 connector
F	USB2.0 connector x4	N	DC power supply connector
G	COM port x4	O	PCIe x4slot x 1 (MXC-2300-3E1) 5V 32-Bit PCI slot (MXC-2300-3S)
H	Audio Jacks	P	5V 32-Bit PCI slots x 2

Table 1-1: Front Panel I/O Connector Legend

1.5.1 Power Button

The power button is a non-latched push button with a blue LED indicator. System is turned on when the button is depressed, and the power LED lights. If the system hangs, depress the button for 5 seconds to turn off the system completely.

1.5.2 LED Indicators

In addition to the LED of the power button, three LEDs on the front panel indicate the following.

LED indicator	Color	Description
Watchdog (WD)	Yellow	Indicates watchdog timer status. When watchdog timer starts, the LED flashes. When the timer is expired, the LED remains lit..
Hard disk drive (HD)	Red	Indicates the HDD operating state. When the SATA hard drive or CFast card is active, the LED indicator flashes.
Diagnostic (DG)	Green	When lit continuously, indicates no physical storage is connected, and if blinking, indicates no memory is installed on either SODIMM socket.

Table 1-2: LED Indicators

1.5.3 Reset Button

The reset button executes a hard reset for the MXC-2300.

1.6 Digital I/O Connector

The MXC-2300 controller features an onboard isolated digital I/O circuit with a 68-pin VHDCI (Very High Density Cable Interconnect) connector on the front panel. The onboard digital I/O card supports the following features:

16-CH Isolated DI

- ▶ Logic high: 5 to 24 V
- ▶ Logic low: 0 to 1.5 V
- ▶ Input resistance: 8.2K @ 0.75W
- ▶ Isolation type: photocoupler
- ▶ Isolation voltage: 1500 V DC

16-CH Isolated DO

- ▶ Output Type: MOSFET transistor

- ▶ Sink current up to 100 mA (sustained loading) or 250 mA (peak loading) on each isolated output channel
- ▶ Supply voltage: 5 to 35 V DC
- ▶ Isolation type: Digital Isolator
- ▶ Isolation voltage: 1500 V DC
- ▶ Flywheel diode for VDD on all DO channels

Isolated 5V DC Power Source for DO

- ▶ Supply voltage: 5 ± 0.5 V DC
- ▶ Supply current: 180 mA (maximum)
- ▶ Isolation type: DC-to-DC transformer
- ▶ Isolation voltage: 1500 VRMS (channel to system)

General Specification

- ▶ 68-pin VHDCI (Very High Density Cable Interconnect) connector (mating with AMP 787082-7) on the front panel
- ▶ Optional accessories: DIN-68S-01 and ACL-10568-1
- ▶ Data transfer: programmed IO
- ▶ Software Driver support: please download from our website

	Pin	Signal	Pin	Signal	Pin	Signal
	1	+VDD	24	DI1_L	47	EOGND
	2	EOGND	25	DI0_H	48	DO10
	3	DO7	26	DI0_L	49	EOGND
	4	EOGND	27	DI11	50	DO9
	5	DO6	28	ISO_COM	51	EOGND
	6	EOGND	29	DI10	52	DO8
	7	DO5	30	ISO_COM	53	DI7_H
	8	EOGND	31	DI9	54	DI7_L
	9	DO4	32	ISO_COM	55	DI6_H
	10	EOGND	33	DI8	56	DI6_L
	11	DO3	34	ISO_COM	57	DI5_H
	12	EOGND	35	+VDD	58	DI5_L
	13	DO2	36	+V5DIO_CN_ISO	59	DI4_H
	14	EOGND	37	EOGND	60	DI4_L
	15	DO1	38	DO15	61	DI15
	16	EOGND	39	EOGND	62	ISO_COM
	17	DO0	40	DO14	63	DI14
	18	EOGND	41	EOGND	64	ISO_COM
	19	DI3_H	42	DO13	65	DI13
	20	DI3_L	43	EOGND	66	ISO_COM
	21	DI2_H	44	DO12	67	DI12
	22	DI2_L	45	EOGND	68	ISO_COM
	23	DI1_H	46	DO11		

Table 1-3: Digital I/O Connector Pin Signals

DI	DIn_H	High input of isolated differential DI channel (n=0 to 7)
	DIn_L	Low input of isolated differential DI channel (n=0 to 7)
	DIn	Input of isolated DI channel (n=8 to 15)
	ISO_COM	Common ground of isolated DI channel 8 to 15
DO	DO _n	Output of isolated DO channel (n=0 to 15)
	EOGND	Ground return path of isolated DO channel 0 to 15 and +V5DIO_CN_ISO
	+VDD	Power input signal for flywheel diode of isolated DO channel 0 to 15
	+V5DIO_CN_ISO	Isolated 5V DC power, maximum output 180mA

Table 1-4: Digital I/O Connector Pin Legend

1.6.1 Isolated Digital Input Circuits

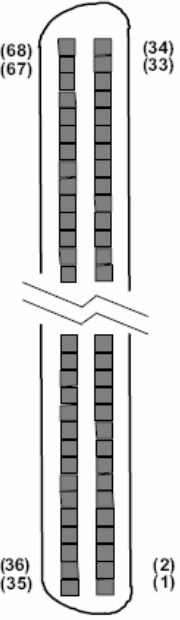
Input accepts voltages up to 24V, with input resistors of 8.2 k Ω , with connections between outside signals as shown.

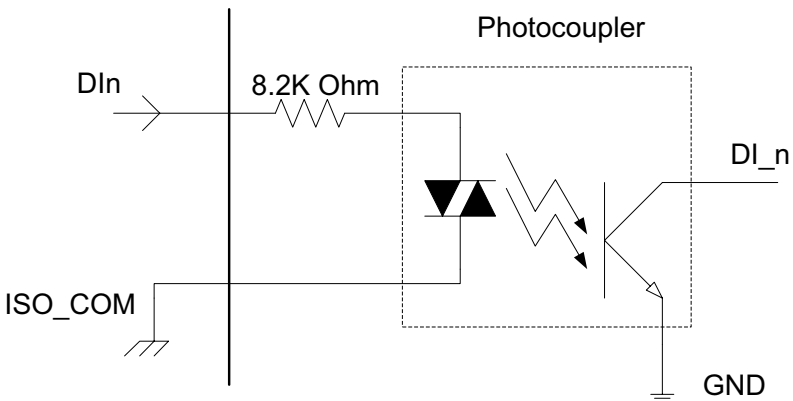

Figure 1-8: Isolated Digital Input Circuit

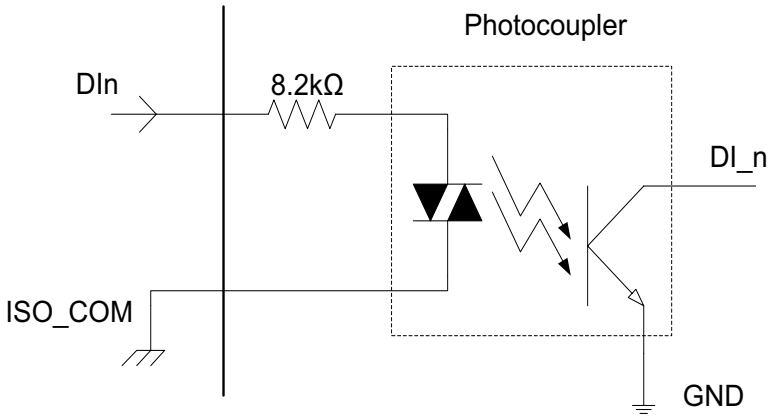

Figure 1-9: Isolated Digital Input Differential Input Circuit

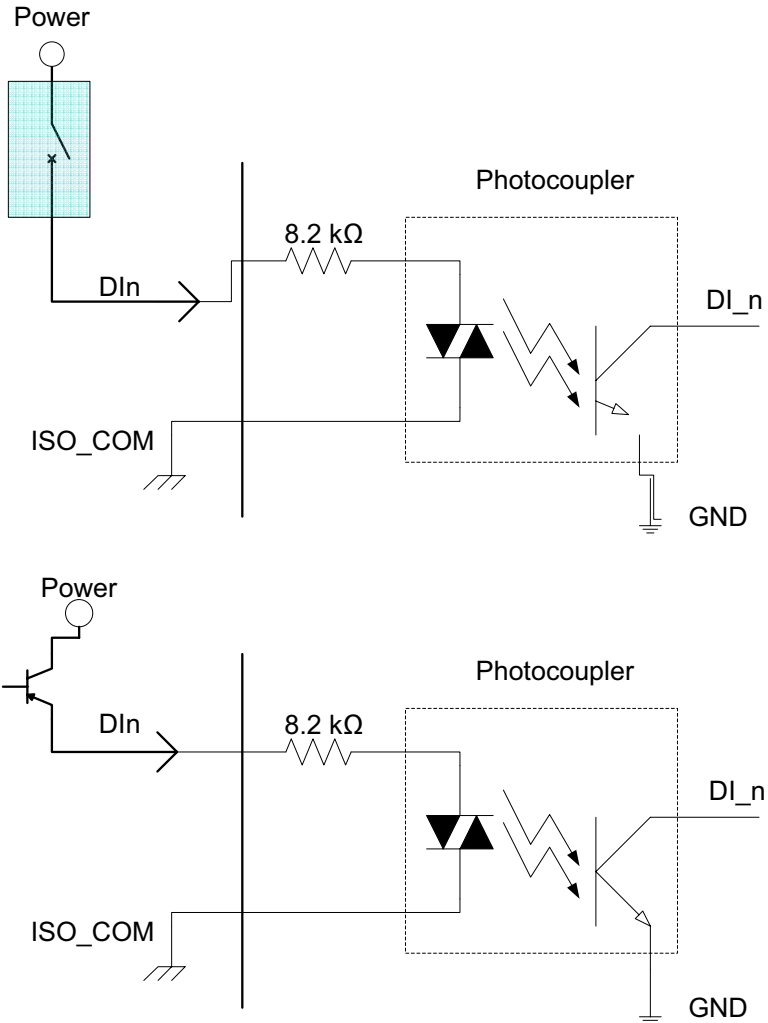

Figure 1-10: Isolated Digital Input Sample Application Circuit

1.6.2 Isolated Digital Output Circuits

Each isolation digital output channel adopts a MOSFET transistor, capable of driving peak current up to 250mA (sustained current up to 100 mA) with voltage ranges from 5V to 35V.

The VDD pin is connected in series with a flywheel diode protecting the driver during inductance loading, such as relay, motor, or solenoid, wherein the VDD must connect to external power to form a flywheel current loop.

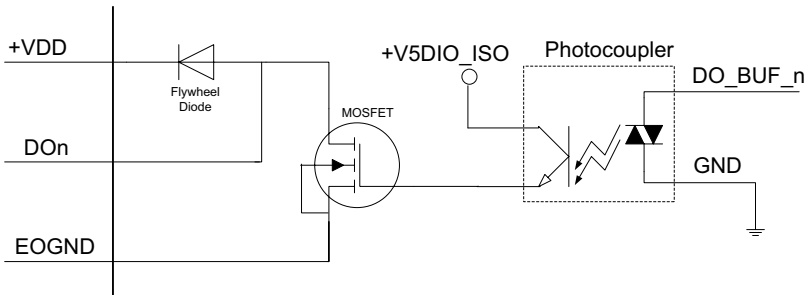

Figure 1-11: Isolated Digital Output Circuits

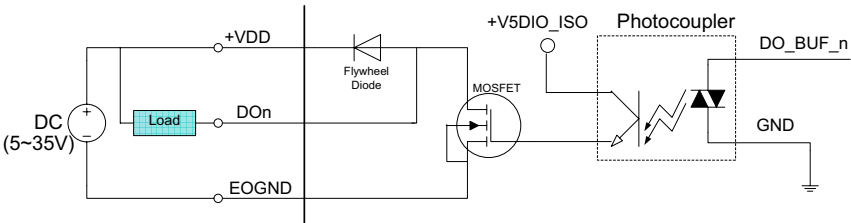

Figure 1-12: Isolated Digital Output Sample Application Circuit

1.6.3 Digital I/O Windows Driver and API

The MXC-2300 DI/O incorporates ADLINK's PCMe-1432 Windows driver, on the bundled driver CD or downloadable from Adlink's MXC-2300 web support page (driver for MXC-2300 DI/O).

1.6.4 Controller Area Network (CAN) Port

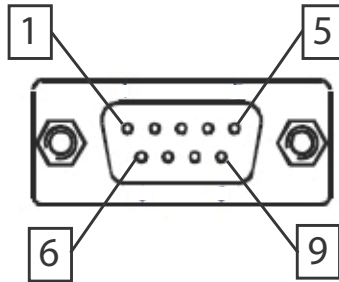

Figure 1-13: CAN Port

Pin	Signal	Pin	Signal
1	N/A	6	N/A
2	CAN_L	7	CAN_H
3	GND	8	N/A
4	N/A	9	N/A
5	N/A		

Table 1-5: CAN Port Pin Assignments

The Controller Area Network (CAN) interface supports dual-port isolated CAN connection that can run independently or bridged at the same time. The built-in CAN controller is a Phillips SJA1000, providing bus arbitration and error detection with auto correction and re-transmission capability, and features:

- ▶ Dual independent CAN network operation
- ▶ Bridge function support
- ▶ Compatibility with CAN specification 2.0 parts A and B
- ▶ Optically isolated CAN interface with up to 1000 Vrms isolation protection
- ▶ Direct memory mapping to CAN controllers
- ▶ CAN controller bit rate up to 1Mbits/s

- ▶ Powerful master interface for CANopen, DeviceNet and SDS application layer protocol

1.6.5 USB 2.0 Ports

The MXC-2300 provides four USB 2.0 ports supporting Type A USB connection on the front panel. All USB ports are compatible with high-speed, full-speed and low-speed USB devices. The MXC-2300 supports multiple boot devices, including USB flash drive, USB external hard drive, USB floppy, USB CD-ROM and others. The boot priority and boot device can be configured in BIOS. Please refer to Section B.4: Security on page 82 for details.

1.6.6 USB 3.0 Ports

The MXC-2300 provides a USB 3.0 port supporting Type A USB 3.0 connection on the front panel, compatible with super-speed, high-speed, full-speed and low-speed USB devices.

1.6.7 Gigabit Ethernet Ports

The MXC-2300 has two Gigabit Ethernet ports on the front panel, supporting the Intel WG1210IT GbE controller, which provides:

- ▶ IEEE 802.3az Energy Efficient Ethernet
- ▶ IEEE 1588/802.1AS precision time synchronization
- ▶ IEEE 802.3Qav traffic shaper
- ▶ Interrupt moderation, VLAN support, IP checksum offload
- ▶ PCIe OBFF (Optimized Buffer Flush/Fill) for improved system power management
- ▶ Four transmit and four receive queues
- ▶ RSS and MSI-X to lower CPU utilization in multi-core systems
- ▶ ECC - error correcting memory in packet buffers
- ▶ Wake-On-LAN
- ▶ NC-SI for increased bandwidth passthrough
- ▶ Preboot eXecution Environment (PXE) flash interface
- ▶ Jumbo frame support
- ▶ LAN Teaming

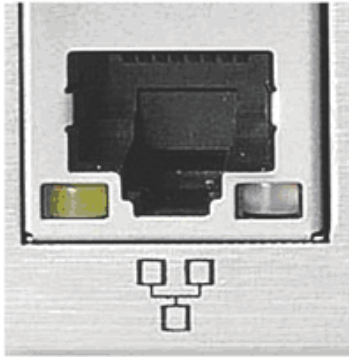

Active/Link Yellow	Speed LED Green/Orange
-----------------------	---------------------------

LED Color	Status	Description
Yellow	OFF	Ethernet port is disconnected.
	ON	Ethernet port is connected with no activity.
	Flashing	Ethernet port is connected and active.

Table 1-6: Active/Link LED

LED Color	Status	Description
Green/Orange	OFF	10 Mbps
	Green	100 Mbps
	Orange	1000 Mbps

Table 1-7: Speed LED

1.6.8 Compact Flash Socket

A Type I Compact-Flash socket provides +3.3V voltage to a CF card. The CF interface is transferred from SATA by an ASIC, and can be an alternative storage device for system installation. The MXC-2300 can boot via a CF card with OS installed. Due to the nature of the SATA interface, the CF card cannot hot-plug and must be installed before powering up the system.

1.6.9 DVI-I Connector

The MXC-2300 provides one DVI-I connector providing connection to an external monitor.



Since VGA signals are analog based, VGA display quality is greatly affected by quality and length of cable used. We strongly recommended VGA cable less than 2 meters in length with effective shielding, such as UL style 2919 AWM.

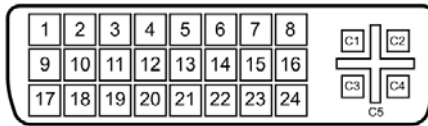

Pin	Signal	Pin	Signal	Pin	Signal	Pin	Signal
1	DVIdata 2-	9	DVIdata 1-	17	DVIdata 0-	C1	Analog Red
2	DVIdata 2+	10	DVIdata 1+	18	DVIdata 0+	C2	Analog Green
3	GND	11	GND	19	GND	C3	Analog Blue
4	CRT DDC clock	12	N/C	20	N/C	C4	Analog horiz. sync
5	CRT DDC data	13	N/C	21	N/C	C5	Analog GND
6	DVIDC clock	14	+5V	22	GND		
7	DVIDC data	15	GND	23	DVI clock +		
8	Analog vert. sync	16	Hot plug detect	24	DVI clock -		

Table 1-8: DVI-I Connector Signals

1.6.10 COM Port Connectors

The MXC-2300 provides four COM ports through D-sub 9 pin connectors. The COM1 & COM2 ports support RS-232/422/485 modes by BIOS setting, while COM3 and COM4 support only RS-232.

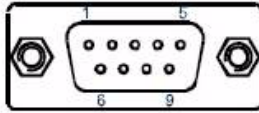

Pin	Signal Name		
	RS-232	RS-422	RS-485
1	DCD#	TXD422-	485DATA-
2	RXD	TXD422+	485DATA+
3	TXD	RXD422+	N/S
4	DTR#	RXD422-	N/S
5	GND	N/S	N/S
6	DSR#	N/S	N/S
7	RTS#	N/S	N/S
8	CTS#	N/S	N/S
9	RI#	N/S	N/S

Table 1-9: D-Sub 9p Signal Function of Com Ports

1.6.11 DisplayPort Connectors

Two displayport connectors on the front panel can connect to VGA, DVI, HDMI and DisplayPort monitors via DisplayPort to VGA adapter cable, DisplayPort to DVI adapter cable, or DisplayPort to HDMI adapter cable and DisplayPort cable.

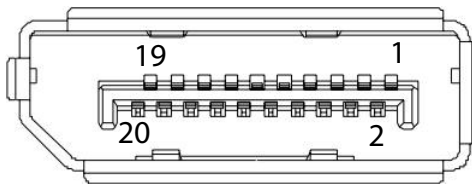

Figure 1-14: DisplayPort Connector

Pin	Signal	Pin	Signal
1	CN_DDPx0+	11	GND
2	GND	12	CN_DDPx3-
3	CN_DDPx0-	13	CN_DDPx_AUX_SEL
4	CN_DDPx1+	14	CN_DDPx_CONFIG2
5	GND	15	CN_DDPx_AUX+
6	CN_DDPx1-	16	GND
7	CN_DDPx2+	17	CN_DDPx_AUX-
8	GND	18	CN_DDPx_HPD
9	CN_DDPx2-	19	GND
10	CN_DDPx3+	20	+V3.3_DDPx_PWR_CN

Table 1-10: DisplayPort Pin Assignments

P/N	Description
30-01119-0000	Passive DisplayPort to HDMI adapter cable
30-01120-0000	Passive DisplayPort to DVI adapter cable
30-01121-0000	Passive DisplayPort to VGA adapter cable
30-01157-0000	Active DisplayPort to DVI adapter cable

Table 1-11: Applicable Cable Types

1.6.12 Audio Jacks

The MXC-2300 implements Intel High Definition audio on a Realtek ALC269 chip. The HD audio supports up to 24-bit, 192 KHz sample rate high quality headphone/line out and microphone input. Audio jack access is on the front panel. The pink jack provides microphone input, and the green jack line out.



Color	Signal
Green	lineout
Pink	Mic In

Table 1-12: Audio Jack Signals

1.6.13 DC Power Connector

The DC power supply connector of the MXC-2300 is on the front panel. The power supply connector consists of three pins, V+, chassis ground, and V- from right to left respectively. V+ and V- pins provide DC power input and the chassis ground pin allows connection of the chassis to ground for better EMC compatibility. The DC power input for the MXC-2300 allows a voltage input range from 9 V DC to 32 V DC.



WARNING:

Ensure that the DC power supply:

- ▶ is within the input voltage range defined in the specification
- ▶ is stable and low-noise DC
- ▶ provides sufficient operating current

DC power supply over or under voltage, unstable, or of insufficient power may cause system instability and physical damage

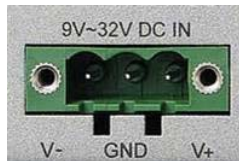

Pin	Signal
1	V+ (DC_IN)
2	GND (CHGND)
3	V- (DGND)

Table 1-13: DC Power Supply Connector Signals

1.6.14 PCI Slot

The MXC-2300 provides two PCI slots, based on the PCIe to PCI bridge, with connection to the host system achieved through a PCIe interface, supporting universal or 5V PCI 32-bit cards operating at 33/66MHz clocks.

1.6.15 PCI Express x4 Slot

The PCI Express x4 slot on the backplane board, based on the PCI Express switch, can support standard PCI Express x4 Gen1/2 cards, with link speed up to 1GB/s.

1.7 Internal I/O connectors

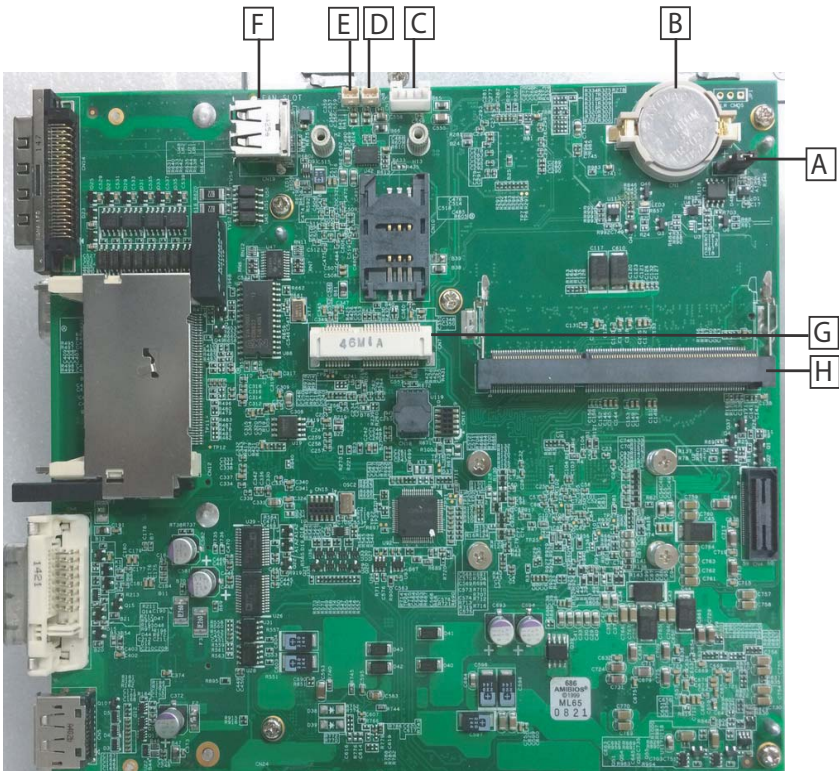

Figure 1-15: Mainboard PCB

A	Clear CMOS jumper
B	CMOS RTC Battery

C	Reserved +5V and +12V connector
D	Extra +5V voltage connector
E	Extra +3.3V voltage connector
F	12V DC fan connector
G	Mini PCI Express slot & USIM socket
H	2nd DDR3L DIMM socket

Table 1-14: Mainboard Connector Legend



Figure 1-16: Backplane Board PCB

A	5V 32Bit PCI slot
B	5V 32Bit PCI slot
C	PCI Express x4 slot
D	Internal USB dongle connector
E	SATA connector
F	Connector to mainboard PCB

Table 1-15: Backplane Board Connector Legend

1.7.1 Clear CMOS Jumper

Upon encountering an abnormal condition preventing the MXC-2300 from booting, the jumper can clear the BIOS content stored in CMOS and restore default settings. To clear CMOS, short pins 2 and 3 of Jumper 2 and then remove the jumper to return to normal mode.



Normal	Clear
JP2 	JP2 

Table 1-16: Clear CMOS Jumper Settings

1.7.2 Internal Reserved +5V and +12V Connector

The MXC-2300 provides one power pin header with +5V and +12V DC power, providing access for PCI and PCI express card external power supplies.

Please refer to Section A.2:Power Supply Reference for +5V and +12V connector power supply specifications

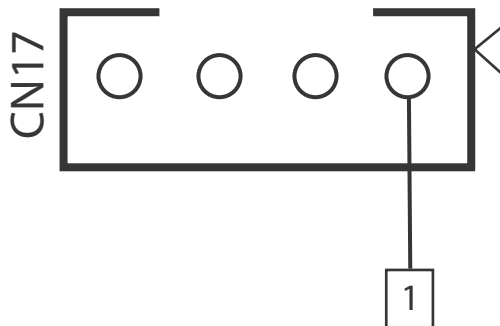

Figure 1-17: +5V and +12V Connector Pin Connector

Pin	Signal
1	+12V
2	GND
3	GND
4	+5V

Table 1-17: +5V and +12V Connector Pin Functions

1.7.3 12V DC Fan Connector

The MXC-2300 provides a DC 12V to USB connector for fan module power. The optional fan module connects to the connector when assembled to the chassis.

Fan speed changes with CPU temperature according to thermal sensor, initiating at 40°C(104°F), and reaching maximum speed at 80°C (176°F). The fan rotates at maximum speed when Power On Self Test begins.

 WARNING:	The USB connector does not support standard USB connections, which may be damaged by the DC 12V power supply.
---	---

1.7.4 Internal USB Connector

The MXC-2300 provides an internal USB dongle connector on the backboard.

1.7.5 SATA Connectors

The MXC-2300 provides one SATA port, supporting up to 3.0 Gb/s (300MB/s) transfer rate. The SATA host controller can be set to operate in IDE or AHCI mode in BIOS. This SATA connector is designed to support a 2.5 inch hard disk drive (HDD) or solid state disk (SSD). The HDD or SSD must be installed into the SATA connector with a HDD bracket. Please refer to Section 3.1 for installation of a 2.5 inch HDD or SSD.

1.7.6 Backboard to System PCB Connector

This connector connects the backboard to a golden finger-equipped mainboard PCB.

This page intentionally left blank.

2 Getting Started

This chapter discusses installation of a hard disk drive, a PCI/PCIe card and a CF card in the system. In addition to connection and use of mini-PCI-E device, wall-mounting is also described.

2.1 Unpacking Checklist

Before unpacking, check the shipping carton for any damage. If the shipping carton and/or contents are damaged, inform your dealer immediately. Retain the shipping carton and packing materials for inspection. Obtain authorization from your dealer before returning any product to ADLINK. Ensure that the following items are included in the package.

- ▶ MXC-2300 controller
- ▶ Accessory box
- ▶ Screw pack for wall-mounting and HDD fixing
- ▶ Quick Start Guide
- ▶ ADLINK All-in-One DVD

2.2 Installing Hard Disk Drives

Before installing hard disk drives, remove the cover from the chassis as follows.

1. Loosen the thumbscrew on the front panel by hand or screwdriver.



2. Withdraw the thumbscrew and remove the top cover by lifting.



3. Remove 2 screws from the back cover.



4. Place the chassis upside down and remove the other 2 screws from the bottom of the back cover.



5. Lift and pull the back cover.

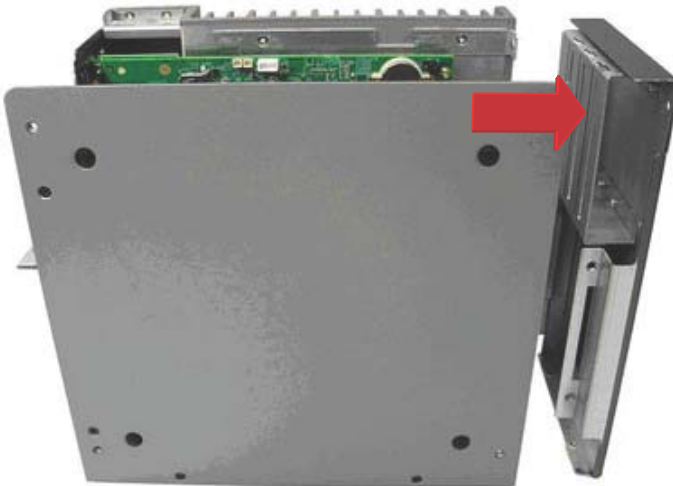

6. Use the 4 M3 screws included in the package to fix a 2.5" HDD or SSD unit to the bracket.



7. Gently reinstall the cover and depress the HDD/SSD bracket to the SATA connector on the PCB.



8. Reverse Steps 3 and 4 to fasten the 4 screws.
9. Replace the top cover and fasten the thumbscrew.

2.3 Installing a PCI/PCIe Card

Follow steps 1-2 in Section 2.2: Installing Hard Disk Drives to remove the top cover before installing a PCI/PCIe card.

1. Insert the PCI/PCIe card into the PCI/PCIe slot. Ensure that the lower edge of the PCI/PCIe card aligns with the alignment guide.

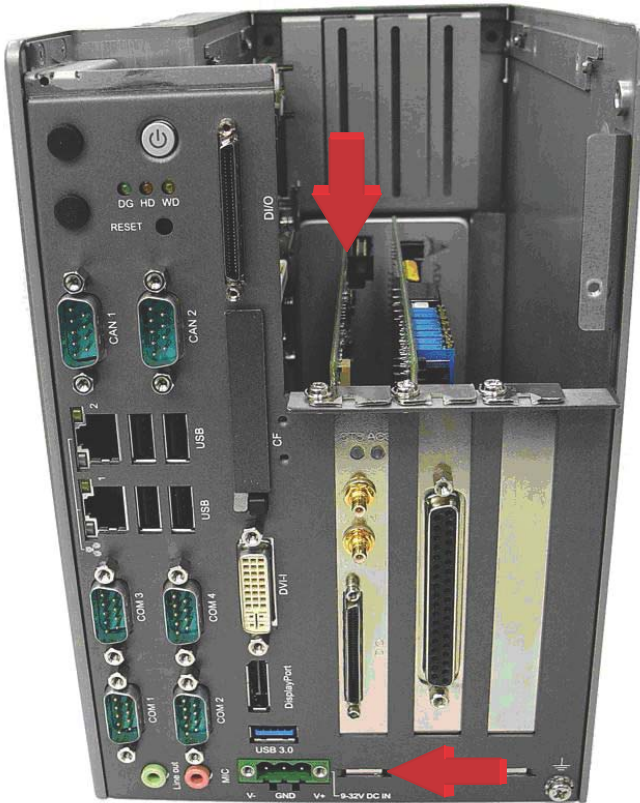

2. Adjust the position of the included card brace to firmly fix the card.

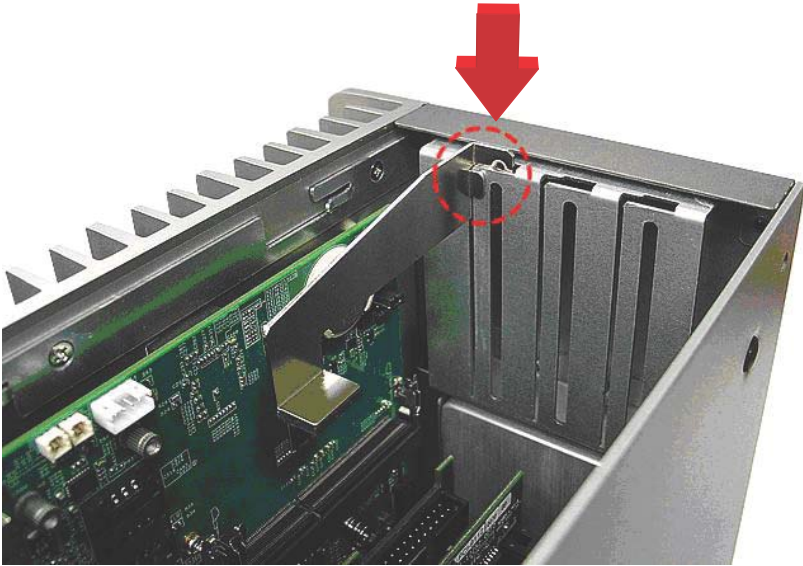

Tighten the screw to fix the brace.



3. Replace the top cover and fasten the thumbscrew.

2.4 Installing a mini-PCI-E device

According to steps 1-2 in Section 2.2, remove the top cover.

1. Remove 4 screws from the right side cover.



2. Remove the single screw from the back cover.



3. Place the chassis left side down and lift the left side cover.

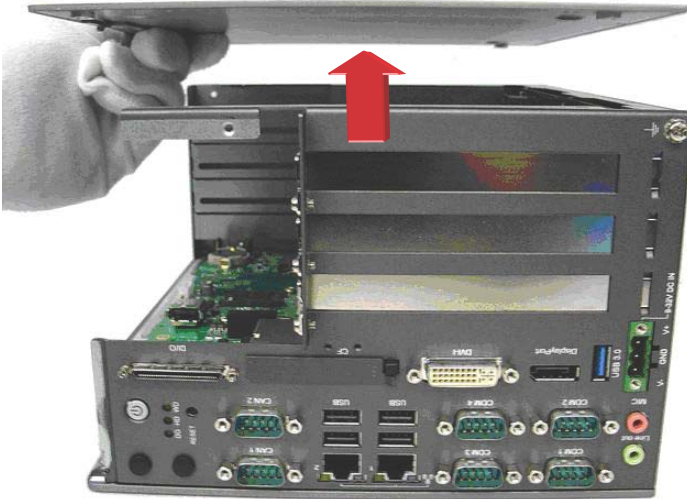

4. Insert the mini-PCI-E wireless module into the slot at an angle.



5. Press the mini-PCI-E wireless module until seated and fix with the 2 M2.5-P-head-L5 screws.

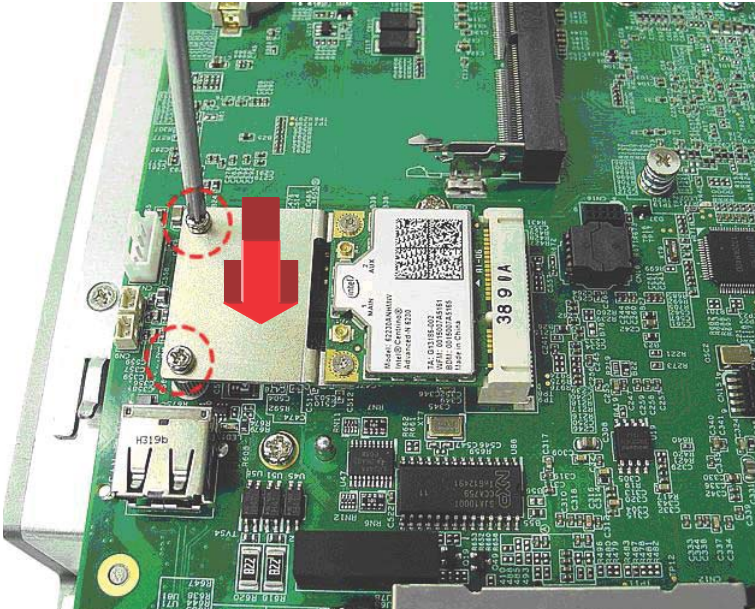

6. Reverse Steps 1 to 3 to reinstall the left side cover and fasten the 5 screws, then replace the top cover and fasten the thumbscrew.

2.5 Installing CF Cards

The MXC-2300 series controller provides an external CF socket to accommodate a CF card. Remove the top cover according to steps 1-2 in Section 2.2.

1. Remove the 2 screws from the external CF socket cover and remove the cover.

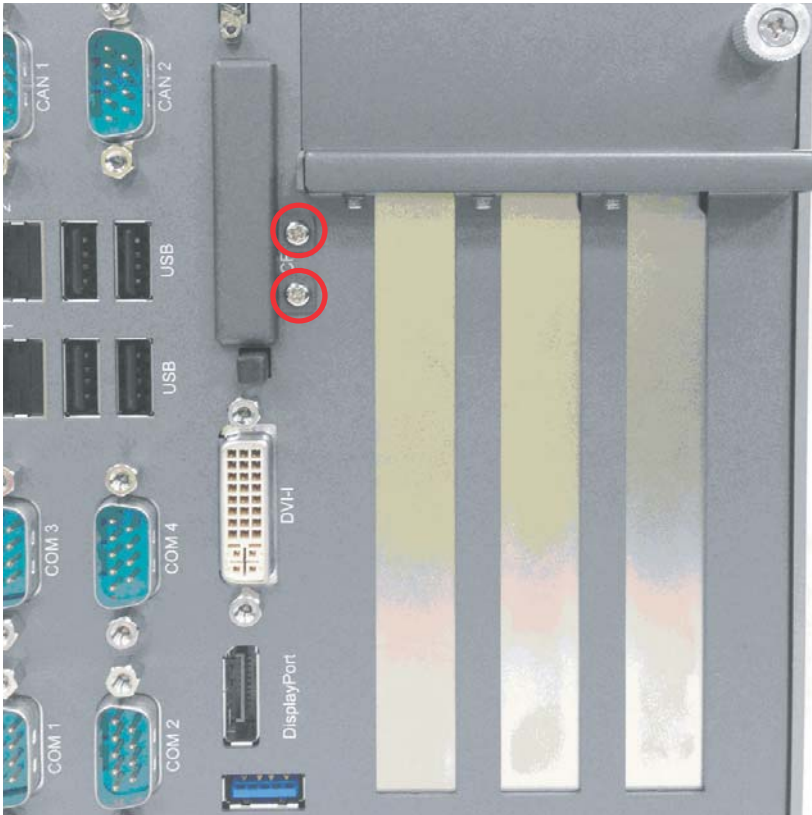

2. Align the CF card with the guide of the CF socket.



3. Gently insert the CF card until it is firmly seated in the socket, as shown.



2.6 Connecting DC Power



Before connecting DC power to the MXC-2300, ensure voltage and polarity are compliant with the DC input. Improper input voltage or polarity can cause system damage.

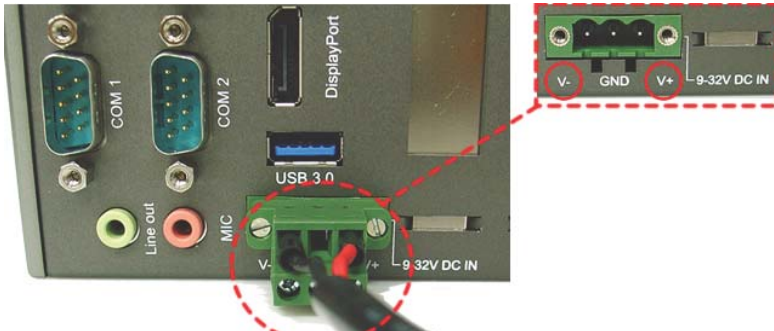

The DC power input connector of the MXC-2300 has V+, V- , and chassis ground pins, and accepts input voltage as shown previously. Connect DC power as shown. Two screws fasten to secure the plug.

2.7 Wall-mounting the MXC-2300



All dimensions shown are in mm (millimeters).

The MXC-2300 is shipped with wall-mount brackets and accessory screws.

Wall-mounting procedures follow.

1. Remove the 4 plastic pads from the corners.

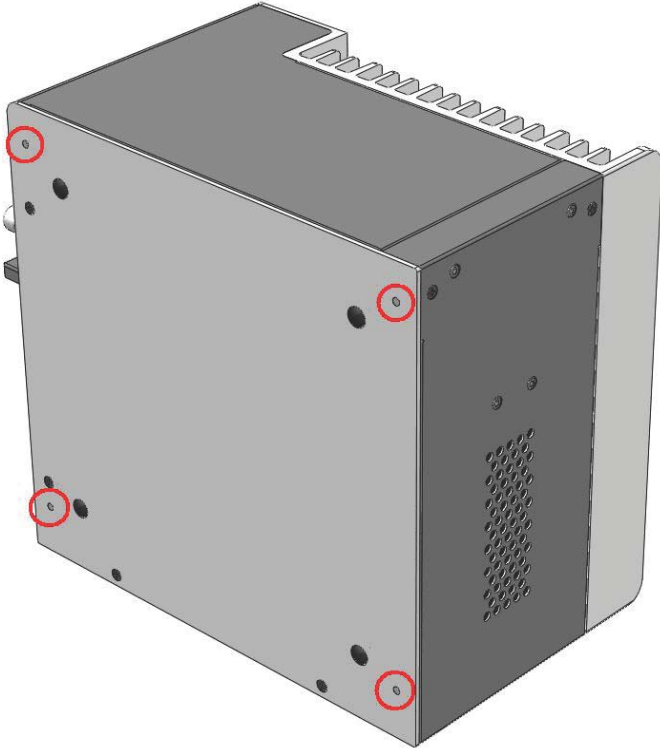

2. Use the 4 M4 screws shipped with the controller to fix the 2 wall-mount brackets, also included, to the chassis, according to the spacing dimensions of the screw holes and brackets, as shown.

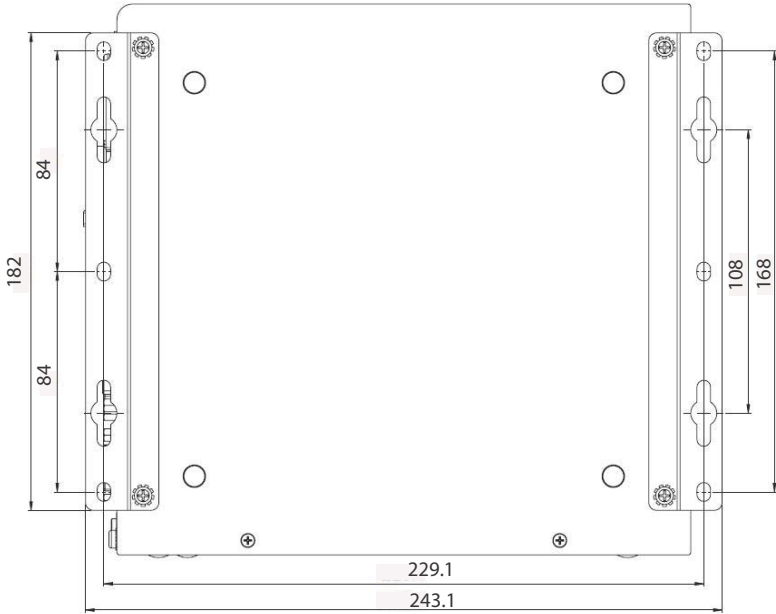
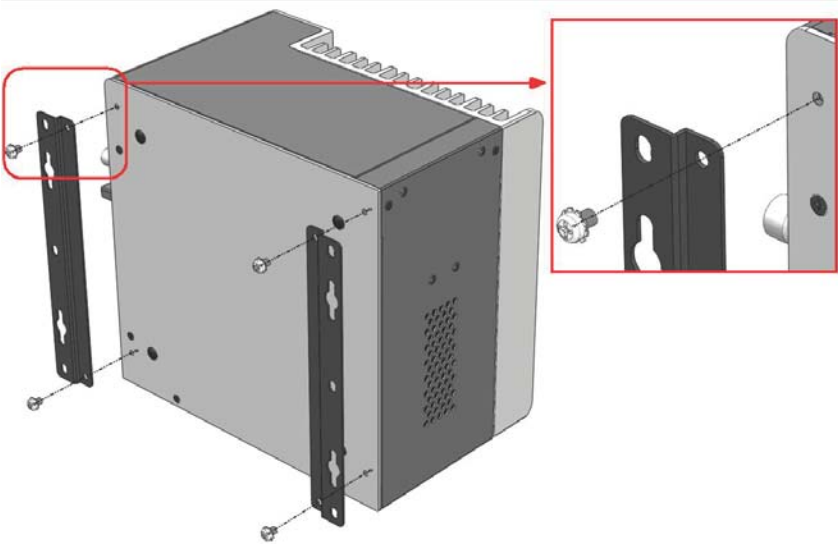

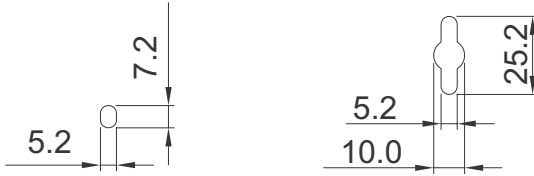

3. Once final assembly as shown is complete, mount the MXC-2300 on the wall via screw holes.

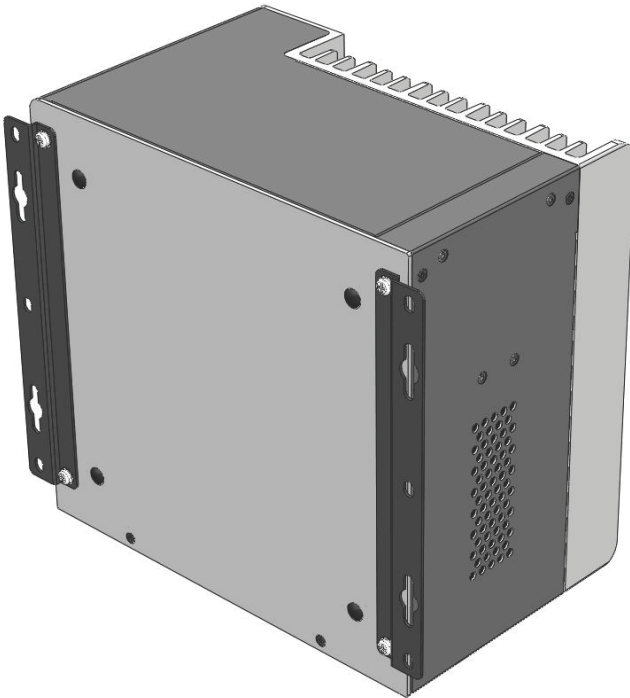

2.8 Optional Fan Module

The MXC-2300 can be optionally equipped with an easily installed fan module providing heat dissipation.

To install the fan module:

1. Follow steps 1-2 in Section 2.2 to remove the top cover. Seat the fan module in the chassis.



2. Slide the fan module back until USB connection is secured, as shown.

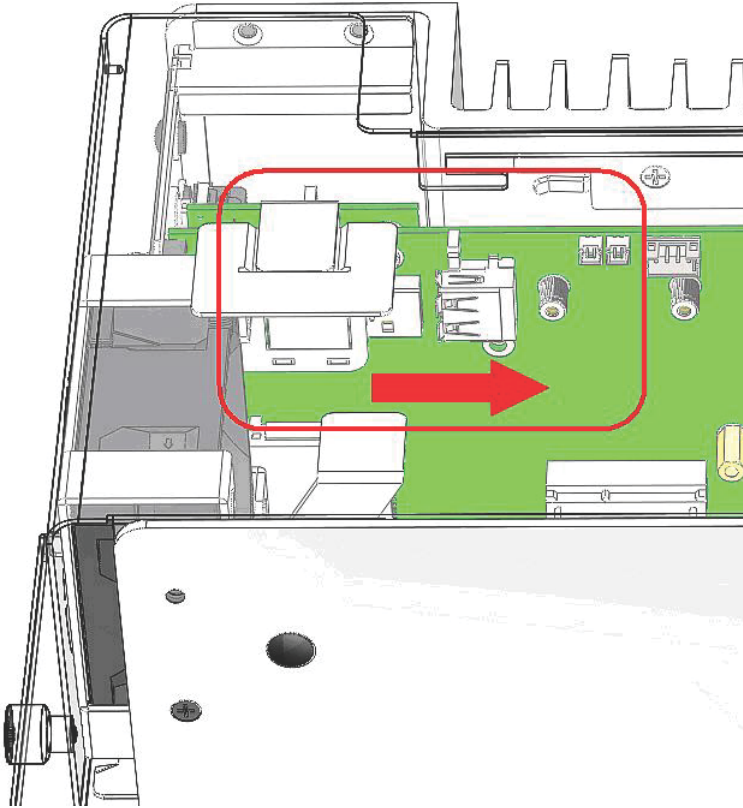

3. Replace the thumbscrews.

2.9 Cooling Considerations

Heat-generating components of the MXC-2300 (such as CPU and PCH) are all situated on the left side of the system. These components directly contact the heat sink via thermal pads and dissipate heat generated by the components. To maximize efficiency of heat dissipation, maintain a minimum of 2 inches (5 cm) clearance on the top of the MXC-2300 controller.

3 Driver Installation

After installing the operating system, all related drivers must be installed for the system to function properly. This section describes the drivers needed for Windows operating systems and the procedures to install them. For other OS support, please contact ADLINK for further information.

The MXC-2300 enables full driver support for systems running Windows 8 32 or 64 bit.



NOTE:

Ensure the Microsoft Windows OS is fully installed before installing any drivers, since most standard I/O device drivers are included therein

It is recommended that drivers be installed as follows.

1. Chipset driver
2. Graphics driver
3. Ethernet driver
4. Audio driver
5. USB 3.0 driver
6. Intel Management Engine driver
7. WDT (watchdog timer) driver
8. Digital Input/Output driver

3.1 Installing the Chipset Driver

The chipset driver directs the operating system to configure the Intel® NM10chipset components in order to ensure that the following features function properly:

- ▶ SATA Storage Support
- ▶ USB Support
- ▶ Identification of Intel® Chipset Components in the Device Manager

1. Close any running applications.
2. Insert the ADLINK All-in-One DVD. The chipset drivers are located in:
x:\Driver Installation\Matrix\MXC-2300\Win7_32bit\Chipset\
x:\Driver Installation\Matrix\MXC-2300\Win7_64bit\Chipset\
where x: denotes the DVD-ROM drive.
3. Execute Setup.exe and follow onscreen instructions to complete the setup.
4. After installation is complete, reboot the system.

3.2 Installing the Graphics Driver

The MXC-2300 is equipped with the Intel® HD Graphics 4000 integrated in the Intel® Core i7.

To install the graphics driver:

1. Close any running applications.
2. Insert the ADLINK All-in-One DVD. The graphics drivers are located in:
x:\Driver Installation\Matrix\MXC-2300\Win7_32bit\Graphics\
x:\Driver Installation\Matrix\MXC-2300\Win7_64bit

\Graphics

where x: denotes the DVD-ROM drive.

3. Execute Setup.exe and follow onscreen instructions to complete the setup.
4. After installation is complete, reboot the system.

3.3 Installing the Ethernet Driver

1. Close any running applications.
2. Insert the ADLINK All-in-One DVD. The drivers are located in:
x:\Driver Installation\Matrix\MXC-2300\Win7_32bit\LAN-Intel\
x:\Driver Installation\Matrix\MXC-2300\Win7_64bit\LAN-Intel\
where x: denotes the DVD-ROM drive.
3. Execute setup.exe and follow onscreen instructions to complete the setup.
4. After installation is complete, reboot the system.

3.4 Installing the Audio Driver

The MXC-2300 supports Intel High Definition audio using the Realtek ALC269 audio codec.

1. Close any running applications.
2. Insert the ADLINK All-in-One DVD. The drivers are located in:
x:\Driver Installation\Matrix\MXC-2300\Win7_32bit\Audio\
x:\Driver Installation\Matrix\MXC-2300\Win7_64bit\Audio\
where x: denotes the DVD-ROM drive.
3. Execute Setup.exe and follow onscreen instructions to complete the setup.
4. After installation is complete, reboot the system.

3.5 Installing the USB 3.0 Driver

The MXC-2300 supports USB 3.0 using Intel Atom E3845 SoC chipset.

1. Close any running applications.
2. Insert the ADLINK All-in-One DVD. The drivers are located in:
x:\Driver Installation\Matrix\MXC-2300\Win7_32bit\
USB3.0\
x:\Driver Installation\Matrix\MXC-2300\Win7_64bit\
USB3.0\
where x: denotes the DVD-ROM drive.
3. Execute Setup.exe and follow onscreen instructions to complete the setup.
4. After installation is complete, reboot the system.

3.6 Installing the Intel Management Engine Driver

The MXC-2300 supports the Intel Management Engine on the Intel QM77 chipset.

1. Close any running applications.
2. Insert the ADLINK All-in-One DVD. The drivers are located in:
x:\Driver Installation\Matrix\MXC-2300\Win7_32bit\
ManageEngine\
x:\Driver Installation\Matrix\MXC-2300\Win7_64bit\
ManageEngine\
where x: denotes the DVD-ROM drive.
3. Execute Setup.exe and follow onscreen instructions to complete the setup.
4. After installation is complete, reboot the system.

3.7 Installing the WDT Driver/API

A WDT (watchdog timer) is a hardware mechanism resetting the system when the operating system or application is halted. A typical usage of WDT is to start the timers and periodically reset the timer, and when timer is expired, the system resets.

To install the WDT driver/API for the MXC-2300:

1. Close any running applications.
2. Ensure that you have Administrator privileges.
3. Download Microsoft® Visual C++ 2005 Redistributable Package x86 or x64 version at: <http://www.microsoft.com/en-us/download/details.aspx?id=3387>
This is necessary for WDT operation.
4. Insert the ADLINK All-in-One DVD. The drivers are located in:
x:\Driver Installation\Matrix\MXC-2300\Win7_32bit\WDT\
x:\Driver Installation\Matrix\MXC-2300\Win7_64bit\WDT\
where x: denotes the DVD-ROM drive.
5. Execute Setup.exe and follow onscreen instructions to complete the setup.
6. After installation is complete, reboot the system.

3.8 Installing the DI/O Driver/API

The MXC-2300 also provides 16 channels for DI and 16 for channels DO based on the PCMe-1432.

To install the DI/O driver/API:

1. Close any running applications.
2. Ensure that you have Administrator privileges.
3. Insert the ADLINK All-in-One DVD. The drivers are located in:
x:\Driver Installation\Matrix\MXC-2300\Win7_32bit\DIO\
x:\Driver Installation\Matrix\MXC-2300\Win7_64bit\DIO\
where x: denotes the DVD-ROM drive.
4. Execute Setup.exe and follow onscreen instructions to complete the setup.
5. After installation is complete, reboot the system.
6. The PCMe-1432 DIO API library and sample programs are in the MXC2300_DIO folder, with default location
C:\Program Files\ADLINK\MXC2300_DI

This page intentionally left blank.

Appendix A Power Supply & Consumption



NOTE:

Information in this Appendix is for power budget planning and design purposes only. Actual power consumption may differ based on final application.

A.1 Power Consumption Reference

Power consumption as follows is based on lab data in which 24V DC is applied and current is measured by the DC power supply. The power consumption (W) is calculated as the product of applied voltage (V) and the current (A).

Platforms tested for this data have available external I/O interfaces, and are attached to supported devices such as VGA and DVI monitors, CFast card, PS2 keyboard/mouse, USB dummy load (5VDC 500mA), external SATA, COM loopback, and audio loopback, and an internal hard disk driver is installed.

No internal PCI/PCIe/mini PCIe slots are occupied.

Information is presented for reference only. Actual power consumption will vary with different attached devices and platform operations.

Power Supply: 24VDC	Power Off	System Idle	System Full Load	Recommended Power Supply
Integrated Embedded Computer				
MXC-2300CD	0.1A (2.4W)	0.62A (14.88W)	1.56A (37.44W)	90W /100W

Table A-1: Power Consumption



NOTE:

- ▶ Sufficient power supply for the entire system is required to meet these specifications. At least 100W at 24V input is recommended.
- ▶ Heat generated by add-on PCI/PCIe adapters affects thermal stability. Additional heat dissipation is required when the system operates at high temperatures or in harsh environments with add-on adapters.
- ▶ Power supply specifications shown are for total power consumption of all PCI/PCIe slots at once, not for single slot use.

A.2 Power Supply Reference

+3.3V Power Rail	Maximum 7A	Total Power Supply Max. 25W
+5V Power Rail	Maximum 5A	
+12V Power Rail	Maximum 2A	
-12V Power Rail	Maximum 0.2A	
CN23 +12V	Maximum 1A	
CN23 +5V	Maximum 1A	

Table A-2: Power Supply

A.3 Accessory Cabling

Power supply to add-on cards is provided by the auxiliary power cable (from CN23 to Molex 8981), Part Number 30-20724-0000.



Yellow	12V	Black	GND
Black	GND	Red	5V

Appendix B BIOS Setup

The Basic Input/Output System (BIOS) is a program that provides a basic level of communication between the processor and peripherals. In addition, the BIOS also contains codes for various advanced features applied to the MXC-2300. The BIOS setup program includes menus for configuring settings and enabling features of the MXC-2300. Most users do not need to use the BIOS setup program, as the MXC-2300 ships with default settings that work well for most configurations.

Enter BIOS setup by selecting DEL when the system is powered on the POST (Power On Self Test) message is displayed. The MXC-2300 controller supports one-time Boot Menu allowing selection of boot device. Enter the Boot Menu by selecting F7 at POST.



NOTE:

- ▶ BIOS options listed are for reference only.
- ▶ Different configurations can affect BIOS behavior.
- ▶ Displayed material may reflect only the BIOS version corresponding to initial release and may differ from that of the purchased motherboard.
- ▶ Users are welcome to download the latest BIOS version from our official website.

B.1 Main

Contains basic system information for the MXC-2300.



WARNING:

Changing BIOS settings may lead to incorrect controller behavior and possible inability to boot. In such a case, Section 2.4.4 provides instruction on clearing the CMOS and restoring default settings



BIOS Information

Shows current system BIOS code version and BIOS version.

System Time/System Date

Allows adjustment of system time and date, as follows.

1. Highlight System Time or System Date using the up and down <Arrow> keys
2. Enter new values using the keyboard and select <Enter>
3. Select < Tab > to move between fields.



NOTE:

- ▶ The date must be entered in MM/DD/YY format, and the time in HH:MM:SS.
- ▶ The time is in 24-hour format. For example, 5:30 A.M. appears as 05:30:00, and 5:30 P.M. as 17:30:00.

B.2 Advanced

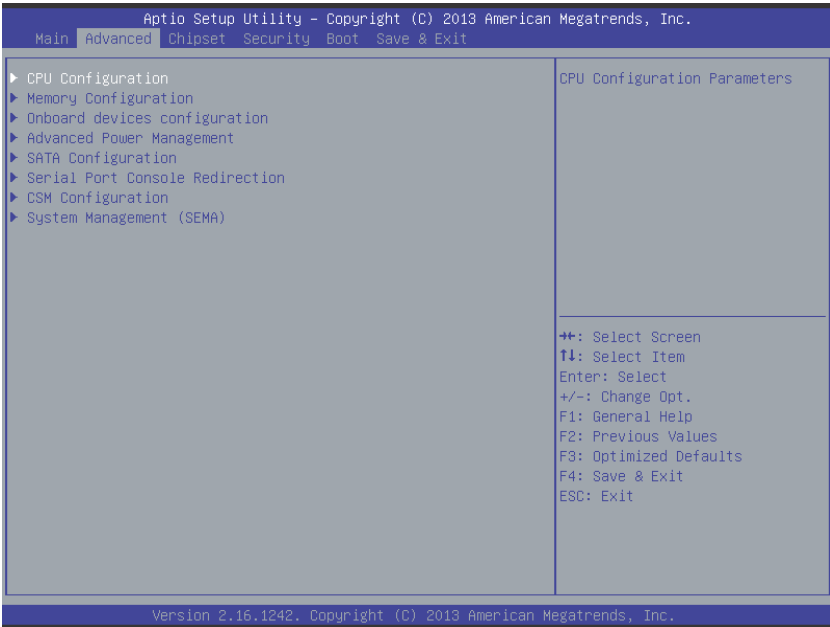

Accesses advanced options of the MXC-2300.



Setting incorrect or conflicting values in Advanced BIOS Setup may cause system malfunction

B.2.1 CPU Configuration

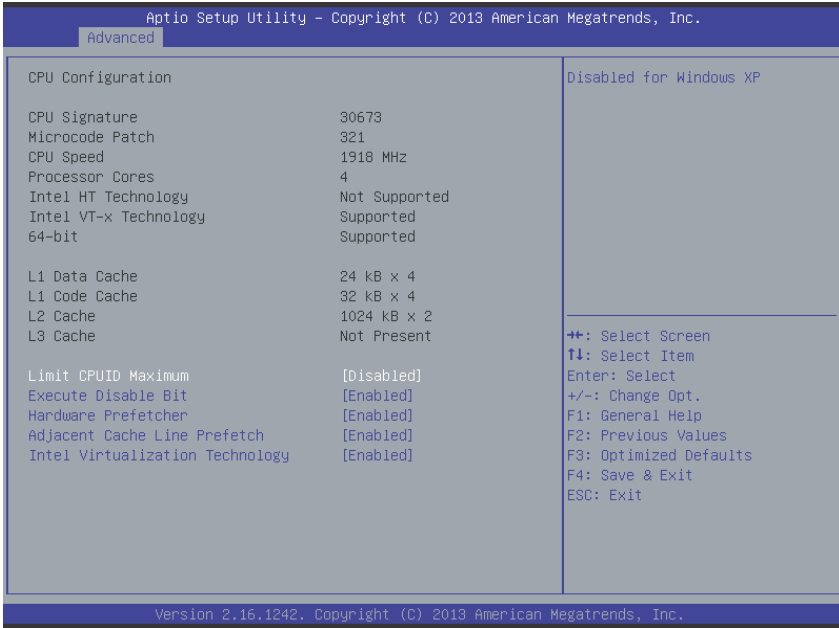

Limit CPUID Maximum

Limits CPUID return value, disable in older OS to avoid system error.

[Disabled (Default)/ Enabled]

Execute Disable Bit

Can prevent certain classes of malicious buffer overflow.

[Disabled/Enabled (Default)]

Hardware Prefetcher

Enables//Disables Mid-Level Cache (L2) streamer prefetcher.

[Disabled/Enabled (Default)]

Adjacent Cache Line Prefetch

Enables//Disables Mid-Level Cache (L2) prefetching of adjacent cache lines.

[Disabled/Enabled (Default)]

Intel Virtualization Technology

When enabled, VMM can utilize additional hardware capabilities provided by Vanderpool Technology.

[Disabled/Enabled (Default)]

B.2.2 Memory Configuration

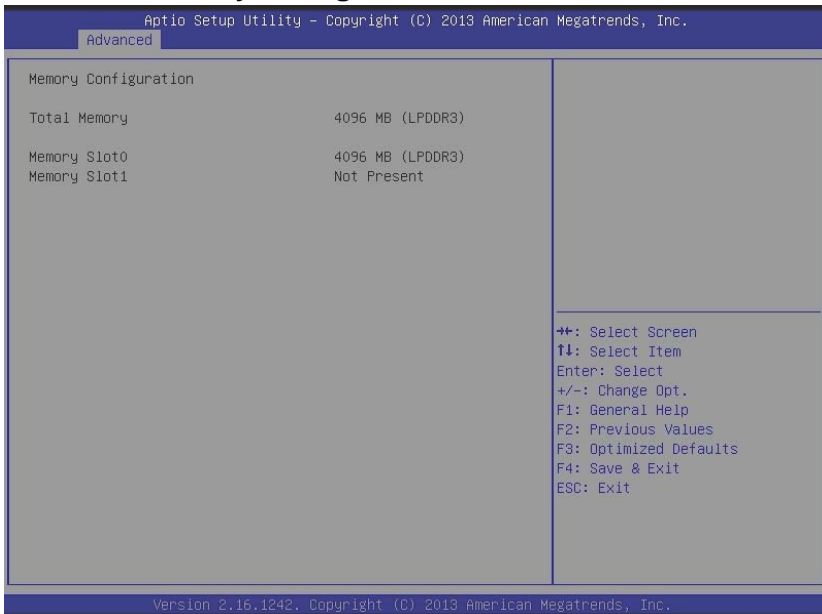

B.2.3 Onboard Device Configuration

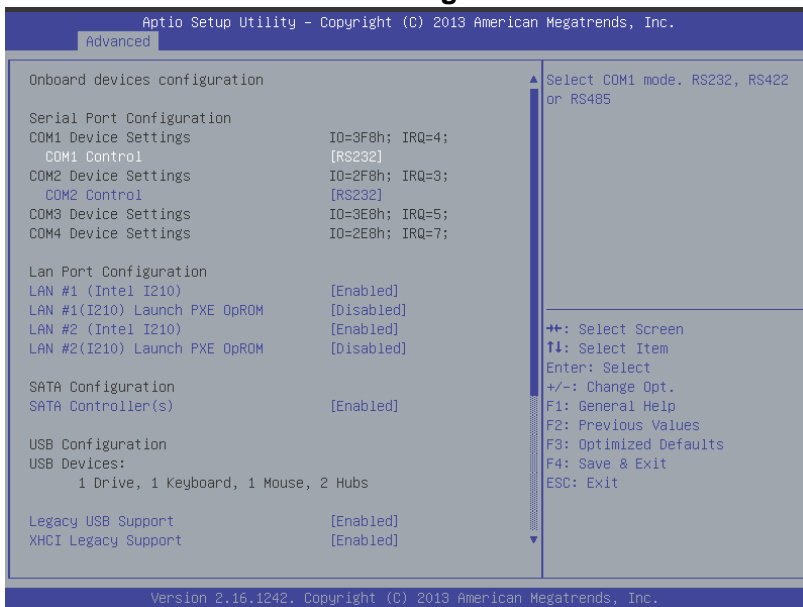

COM1 Control

Select COM1 mode. RS232, RS422 or RS485

[RS232 (Default)/RS422/ RS485]

COM2 Control

Select COM2 mode. RS232, RS422 or RS485

[RS232 (Default)/RS422/ RS485]

LAN #1 (Intel I210)

Enables/disables onboard Intel I210 LAN controller.

[Enabled (Default)/ Disabled]

LAN #1(I210) Launch PXE OpROM

Enables/disables execution of LAN boot-rom to add boot option for legacy network devices.

[Enabled/Disabled (Default)]

LAN #2 (Intel I210)

Enables/disables onboard Intel I210 LAN controller.

[Enabled (Default)/ Disabled]

LAN #2(I210) Launch PXE OpROM

Enables/disables execution of LAN boot-rom to add boot option for legacy network devices.

[Enabled/Disabled (Default)]

SATA Controller(s)

Enables/disables SATA devices

[Enabled (Default)/ Disabled]

Legacy USB Support

[Enabled (Default)/ Disabled/ Auto]

Enabled

When set, supports legacy USB devices.

Disabled

When set, keeps USB devices available only for EFI applications.

Auto

When set, disables legacy support if no USB devices are connected.

XHCI Legacy Support

Enables/disables XHCI controller legacy support.

[Enabled (Default)/ Disabled]

XHCI Hand-off

Enables/disables BIOS support of XHCI Hand-off feature.

[Enabled (Default)/ Disabled]

EHCI Hand-off

Enables/disables BIOS support of EHCI Hand-off feature.

[Enabled/Disabled (Default)]

USB Mass Storage Driver Support

Enables/disables USB Mass Storage Driver Support.

[Enabled (Default)/Disabled]

USB transfer time-out

Time-out value for Control, Bulk, and Interrupt transfers.

[1sec/ 5sec/ 10sec/20sec (Default)]

Device reset time-out

USB mass storage device Start Unit command time-out.

[10sec/20sec (Default)/ 30sec/ 40sec]

Device power-up delay

Device power-up delay mode.

[Auto (Default)/ Manual]

Manual

Device power-up delay in seconds

Delay range is 1~40 seconds, in one second increments.

[5]

B.2.4 Advanced Power Management

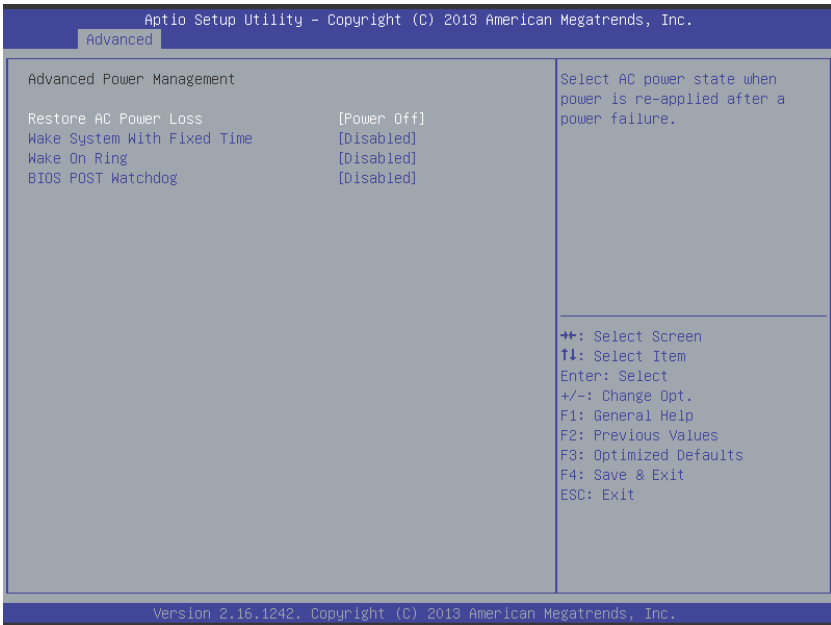

Restore AC Power Loss

Selects AC power state when power is re-applied after a power failure.

(Power Off (Default)/Power On/Last State)

Power Off (Default)

When set, powers the system down when power is restored.

Power On

When set, powers the system on when power is restored.

Last State

When set, powers the system down or on depending on the last system power state when power is restored.

Wake System With Fixed Time

Enables/disables System Wake on Alarm event. When enabled, system will wake on the hour, minute or second specified.

[Enabled/Disabled (Default)]

Enabled

Wake up hour

Select 0-23 For example enter 3 for 3am and 15 for 3pm

[0]

Wake up minute

Set 0 - 59

[0]

Wake up second

Set 0 - 59

[0]

Wake On Ring

Enables/disables RI ping for Wake On Ring function.

[Disabled(Default)/ Enabled]

BIOS POST Watchdog

Sets watchdog timer for BIOS POST process.

[Disabled (Default)/ Enabled]

Disabled

Disables Watchdog Timer.

Enabled

Second Mode: Enables Watchdog Timer in second mode.

[30]

Minute Mode: Enables Watchdog Timer in minute mode.

[30]

B.2.5 SATA Configuration

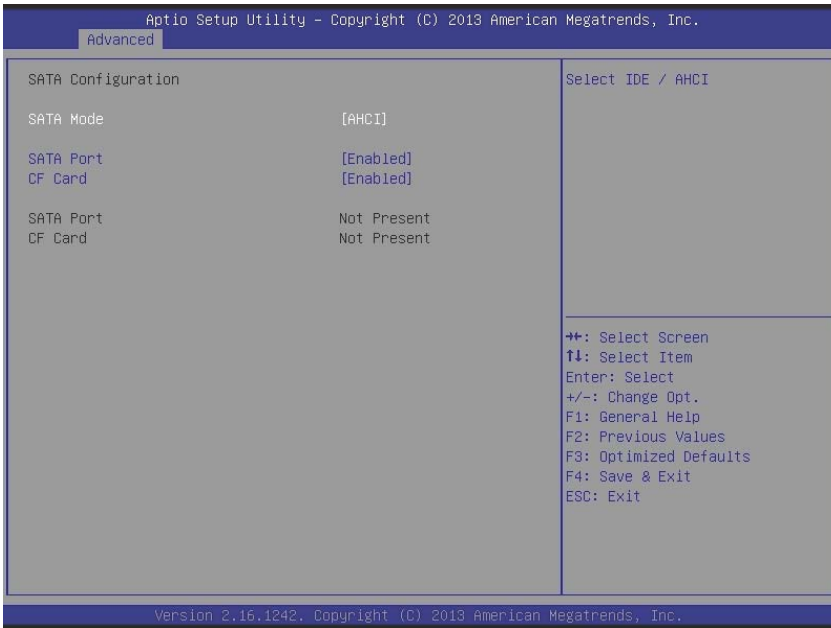

SATA Mode Selection

Determines SATA controller operation.

[IDE/ AHCI (Default)]

SATA Port / CF Card

Enables/disables SATA Port/CF Card.

[Disabled/ Enabled (Default)]

B.2.6 Serial Port Console Redirection

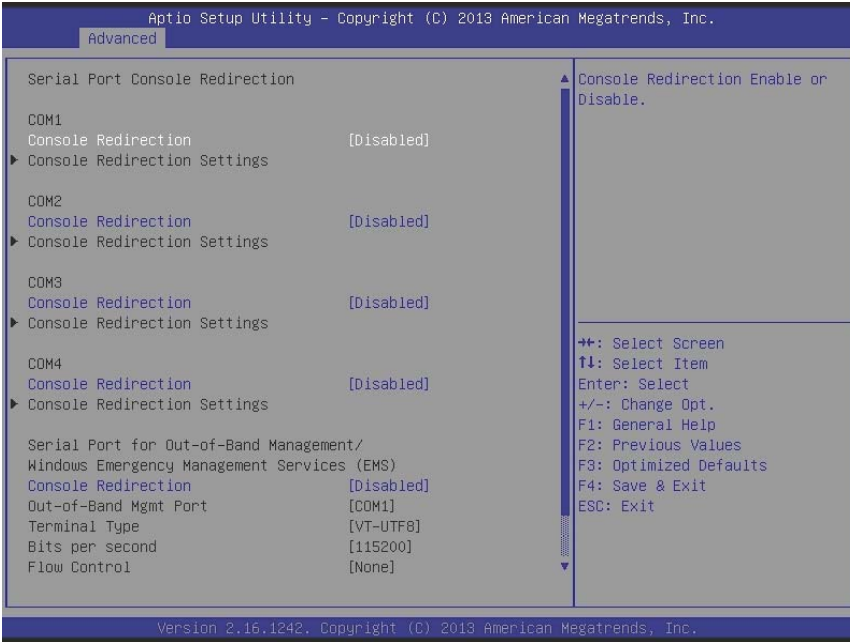

COM1/ COM2/ COM3/ COM4 COM Console Redirection

Enables/disables Console Redirection of COM1/ COM2/ COM3/ COM4.

[Disabled (Default)/ Enabled]

When Enabled:

Console Redirection Settings

Terminal Type

Selects the transmission protocol for the remote terminal console.

[VT100/ VT100+/ VT-UTF8/ ANSI (Default)]

VT100

ASCII char set

VT100+

Extends VT100 to support color, function keys, etc.

VT-UTF8

Uses UTF8 encoding to map unicode chars onto 1 or more bytes

ANSI

Extended ASCII char set

Bits per second

Selects serial port transmission speed, which must be matched on the other side. Long or noisy lines may require lower speeds.

[9600/ 19200/ 57600/ 115200 (Default)]

Data Bits

Data bit count

[7/ 8 (Default)]

Parity

A parity bit can be sent with the data bits to detect some transmission errors.

[None (Default)/ Even/ Odd/ Mark/ Space]

Even

Parity bit is 0 if 1 count in the data bits is even.

Odd

Parity bit is 0 if 1 count in the data bits is odd.

Mark

Parity bit is always 1.

Space

Parity bit is always 0.

Mark and Space Parity do not allow for error detection. They can be used as an additional data bit.

Stop Bits

Stop bits indicate the end of a serial data packet. (A start bit indicates the beginning). The standard setting is 1 stop bit. Communication with slow devices may require more than 1 stop bit.

[1 (Default)/ 2]

Flow Control

Flow control can prevent data loss from buffer overflow.

[None (Default)/ Hardware RTS/ CTS]

Recorder Mode

When enabled only text will be sent, to capture Terminal data.

[Disabled (Default)/ Enabled]

Resolution 100x31

Enables/disables extended terminal resolution.

[Disabled (Default)/ Enabled]

Legacy OS Redirection Resolution

In legacy OS, the Number of Rows and Columns supported redirection

[80x24 (Default)/ 80x25]

Putty KeyPad

Selects Function Key and KeyPad on Putty.

[VT100 (Default)/ LINUX/XTERMR6/SCO/ESCN/VT400]

Redirection After BIOS POST

The settings specify if BootLoader is selected, such that legacy console redirection is disabled before booting to legacy OS. Default value is Enable, such that legacy console redirection is enabled for legacy OS.

[Always Enable (Default)/BootLoader]

(EMS) Console Redirection

Enables/disables Console Redirection of Out-of-Band Mgmt Port.

[Disabled (Default)/ Enabled]

Out-of-Band Mgmt Port

Microsoft Windows Emergency Management Services (EMS) allows remote management of a Windows Server OS through a serial port.

[COM1 (Default)/ COM2/ COM3/ COM4]

Terminal Type

Selects transmission protocol for the remote terminal console.

[VT100/ VT100+/ VT-UTF8 (Default)/ ANSI]

Bits per second

Selects serial port transmission speed, which must be matched on the other side. Long or noisy lines may require lower speeds.

[9600/ 19200/ 57600/ 115200 (Default)]

Flow Control

Can prevent data loss from buffer overflow.

[None (Default)/ Hardware RTS/ CTS]

B.2.7 CSM Configuration

Compatibility Support Module supports legacy Option ROM binaries and OS requiring a legacy BIOS runtime interface.

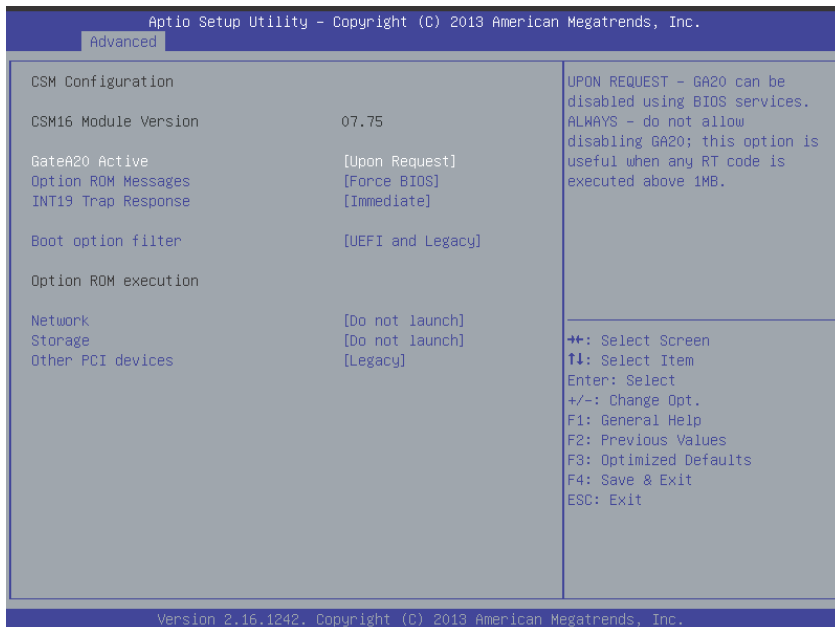

GateA20 Active

GateA20 is an alternate memory access mode allowing communication between old and new Operating Systems

[Upon Request (Default)/ Always]

Upon Request

GateA20 can be disabled using BIOS services.

Always

Prevents GateA20 from being disabled; useful when any RT code exceeding 1 MB is executed

Option ROM Messages

Sets display mode for Optional ROM, whether to show Option ROM information during boot

[Force BIOS (Default)/ Keep Current]

INT19 Trap Response

BIOS reaction on INT19 trapping by Option ROM.

[Immediate (Default)/ Postponed]

Immediate

Executes the trap immediately.

Postponed

Executes the trap during legacy boot.

Boot option filter

Controls boot devices.

[UEFI and Legacy (Default)/ Legacy only/ UEFI only]

Launch Network OpROM policy

Controls execution of UEFI and Legacy PXE OpROM.

[Do not launch (Default) / UEFI only/ Legacy only]

Launch Storage OpROM policy

Controls execution of UEFI and Legacy Storage OpROM.

[Do not launch (Default) / UEFI only/ Legacy only]

Other PCI device ROM priority

For PCI devices other than Network, Mass storage or Video defines which OpROM to launch.

[UEFI only/ Legacy only (Default)]

B.2.8 System Management (SEMA)

Aptio Setup Utility - Copyright (C) 2013 American Megatrends, Inc.

Advanced

System Management (SEMA)

System Information

SMC Bootloader	bl_BMC 1v1
SMC Firmware	TDC ABX-2300 1v1

Temperatures

Board Temperatures

- Current	39 C
- Startup	32 C
- Min	25 C
- Max	41 C

Power Consumption

Current Input Current	0.851 A
Current Input Power	19.796 W
VIN	23.263 V
CPU-Vcore	0.890 V
V1.05	1.358 V
VBAT	3.760 V
V3.30	3.324 V
V5.00	5.143 V
V12.00	12.332 V

Runtime Statistics

++: Select Screen
 ↑↓: Select Item
 Enter: Select
 +/-: Change Opt.
 F1: General Help
 F2: Previous Values
 F3: Optimized Defaults
 F4: Save & Exit
 ESC: Exit

Version 2.16.1242, Copyright (C) 2013 American Megatrends, Inc.

B.3 Chipset

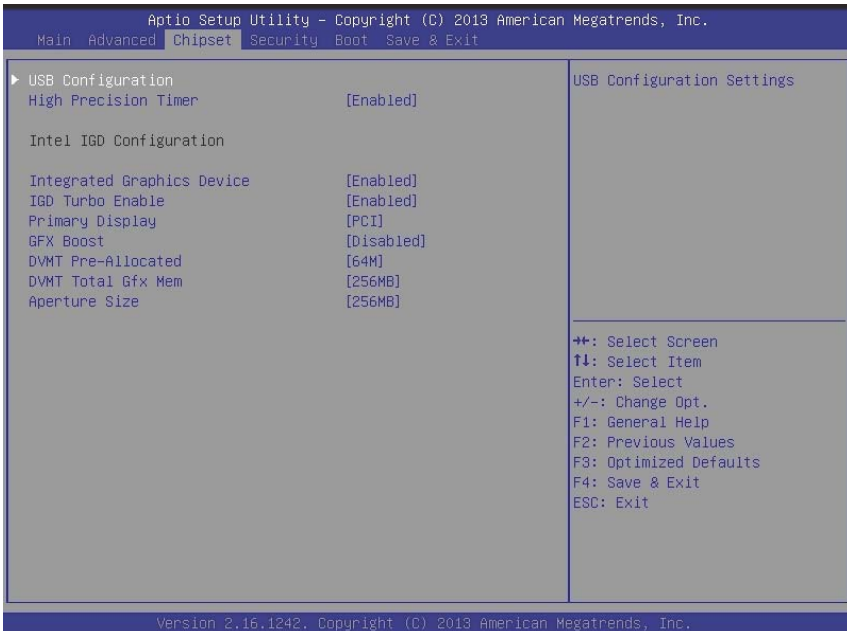

B.3.1 USB Configuration

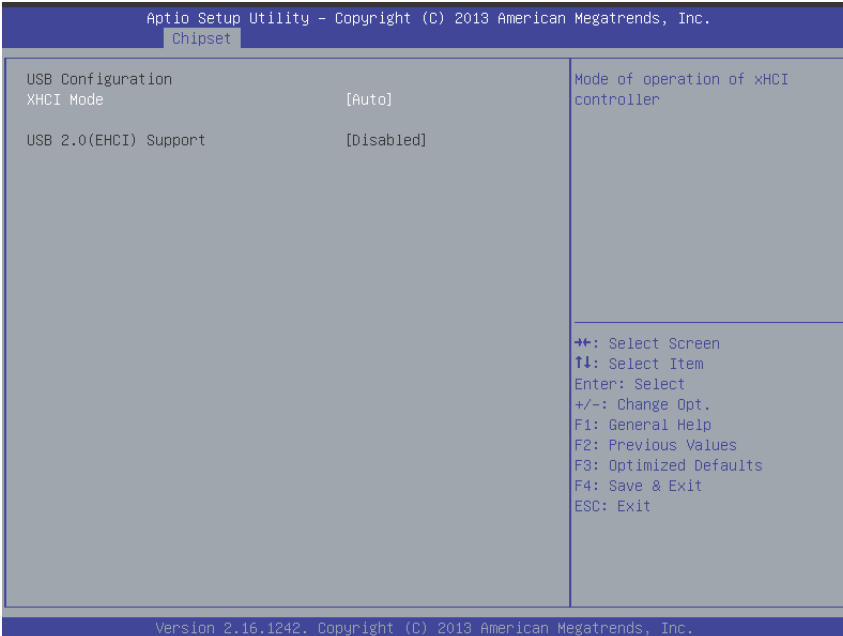

XHCI Mode

Mode of operation of xHCI controller.

[Enabled/ Disabled/ Auto(Default) / Smart Auto]

USB 2.0(EHCI) Support

Controls USB EHCI (USB 2.0) functions. One EHCI controller must always be enabled.

[Disabled(Default)/ Enabled]

B.3.2 High Precision Timer

Enables/disables High Precision Event Timer.

[Enabled (Default)/Disabled]

B.3.3 Intel® IGD configuration

Integrated Graphics Device

[Enabled (Default)/Disabled]

Enabled

Enables Integrated Graphics Device (IGD) when selected as the Primary Video Adaptor

Disabled

Always disables IGD.

IGD Turbo Enable

Enables/disables IGD Turbo

[Enabled (Default)/Disabled]

Primary Display

Selects the IGD/PCI Graphics device to be Primary Display.

[IGD(Default)/ PCI]

GFX Boost

Enables/disables GFX Boost

[Enabled/Disabled (Default)]

DVMT Pre-Allocated

Selects DVMT 5.0 Pre-Allocated (Fixed) Graphics Memory size used by the Internal Graphics Device.

[64MB (Default)/ 96MB/ 128MB/ 160MB/ 192MB/ 224MB/ 256MB/ 288MB/ 320MB/ 352MB/ 384MB/ 416MB/ 448MB/ 480MB/ 512MB]

DVMT Total Gfx Mem

Selects DVMT5.0 Total Graphic Memory size used by the Internal Graphics Device.

[128MB/ 256MB (Default)/ MAX]

Aperture Size

Allows selection of aperture size.

[128MB/ 256MB (Default)/ 512MB]

B.4 Security

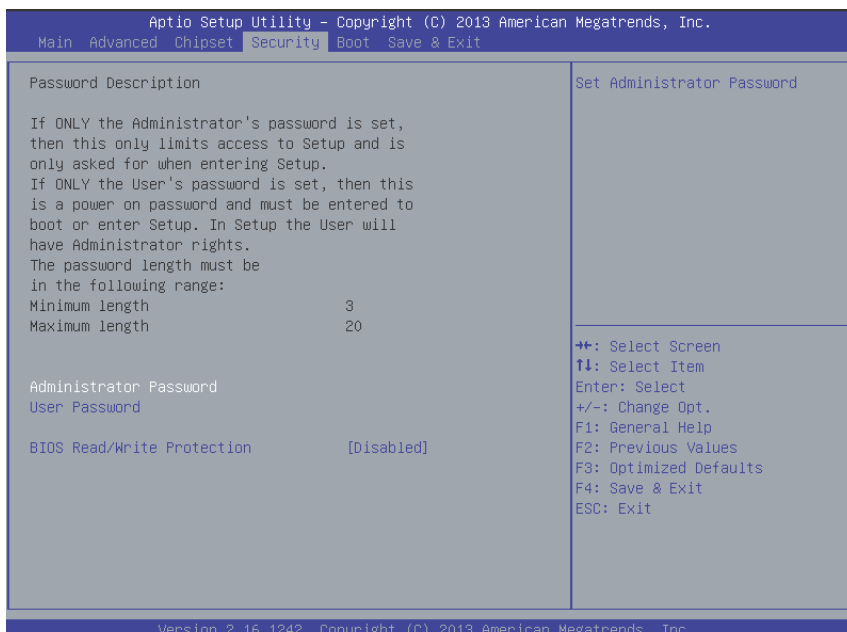

B.4.1 Administrator Password

If only the Administrator password is set, only limits access to Setup and is only requested when entering Setup.

B.4.2 User Password

If only the User password is set, this is a power-on password and must be entered to boot or enter Setup. In Setup the user will have Administrator rights.

B.4.3 BIOS Read/Write Protection

Enables/disables BIOS SPI region read/write protect.

[Enabled/Disabled (Default)]

B.5 Boot

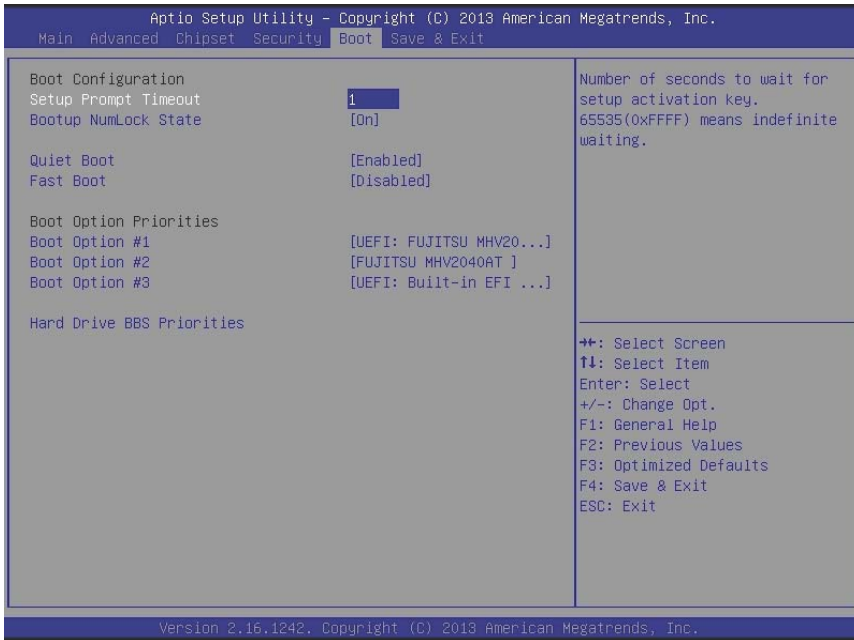

B.5.1 Boot Configuration

Setup Prompt Timeout

Number of seconds to wait for setup activation key (DEL), with input 65535 sets indefinite waiting.

[1]

Bootup NumLock State

Selects keyboard NumLock state.

[On(Default)/ Off]

Quiet Boot

Enables/disables Quiet Boot option.

[Disabled/ Enabled (Default)]

Disabled

Directs BIOS to display POST messages.

Enabled

Directs BIOS to display the OEM logo.

Fast Boot

Enables/disables boot with initialization of a minimal set of devices required to launch active boot option. Has no effect on BBS (BIOS Boot Specification) boot options.

[Disabled (Default)/ Enabled]

B.5.2 Boot Option Priorities

Boot Option #

Specifies the priority of boot devices, with all installed boot devices detected during POST displayed.

B.5.3 Hard Drive BBS Priorities

Sets the order of legacy devices in this group.

B.6 Save & Exit

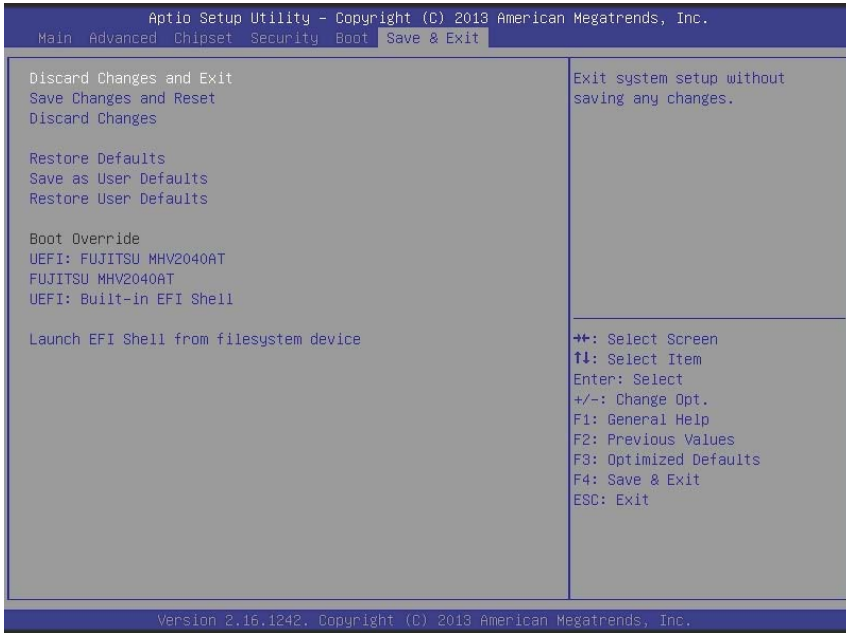

Discard Changes and Exit

Discards all changes and exits BIOS setup

Save Changes and Reset

Saves all changes and reboots the system, with new settings taking effect

Discard Changes

Resets system setup without saving any changes

Restore Defaults

Sets all BIOS options to default settings, designed for maximum system stability but less than maximum performance. Select Restore Defaults if the computer encounters system configuration problems.

Save as User Defaults

Saves all changes to this point as user defaults

Restore User Defaults

Restores user defaults to all setup options

Launch EFI Shell from filesystem device

Attempts to launch EFI Shell application (Shellx64.efi) from one of the available filesystem devices

Appendix C Watchdog Timer (WDT) Function Library

This appendix describes use of the watchdog timer (WDT) function library for the MXC-2300 controller. The watchdog timer is a hardware mechanism provided to reset the system if the operating system or an application stalls. After starting, the watchdog timer in the application must be periodically reset before the timer expires. Once the watchdog timer expires, a hardware-generated signal is sent to reset the system.

C.1 WDT with API/Windows

Matrix WDT API library files and a demo program (incl. source code) can be found on the included driver CD or downloaded from <http://www.adlinktech.com>.

To use the WDT function library for MXC-2300, include the header file `WDT.h` and linkage library `WDT.lib` in the C++ project.

InitWDT

Initializes the watchdog timer function. Must be called before the invocation of any other WDT function.

Syntax

C/C++

```
BOOL InitWDT()
```

Parameters

None

Return codes

TRUE if watchdog timer is successfully initialized.

FALSE if watchdog timer fails to initialize.

SetWDT

Sets the timeout value of the watchdog timer. There are two parameters for this function to indicate the timeout ticks and

unit. ResetWDT or StopWDT should be called before the expiration of watchdog timer, or the system will reset.

Syntax

C/C++

```
BOOL SetWDT(BYTE tick, BYTE unit)
```

Parameters

tick

Specify the number of ticks for watchdog timer. A valid value is 1 - 255.

unit

Specifies the timeout ticks of the watchdog timer.

Value	Description
0	The unit for one tick is one second. For example, when one tick is specified as 100 and the unit as 0, the timeout value is 100 seconds.
1	The unit for one tick is one minute. For example, when one tick is specified as 100 and the unit as 1, the timeout value is 100 minutes.

Return codes

TRUE if timeout value of watchdog timer is successfully set.

FALSE if timeout value of watchdog timer is failed to set.

StartWDT

Start the watchdog timer function. Once the StartWDT is invoked, the watchdog timer starts. ResetWDT or StopWDT should be called before the expiration of watchdog timer, or the system will reset.

Syntax

C/C++

```
BOOL StartWDT()
```

Parameters

None

Return codes

TRUE if watchdog timer is successfully started.

FALSE if watchdog timer is failed to start.

ResetWDT

Reset the watchdog timer. The invocation of ResetWDT allows restoration of the watchdog timer to the initial timeout value specified in SetWDT function. ResetWDT or StopWDT should be called before the expiration of the watchdog timer, or the system will reset.

Syntax

C/C++

```
BOOL ResetWDT()
```

Parameters

None

Return codes

TRUE if watchdog timer is successfully reset.

FALSE if watchdog timer fails to reset.

StopWDT

Stops the watchdog timer.

Syntax

C/C++

```
BOOL StopWDT()
```

Parameters

None

Return codes

TRUE if watchdog timer is successfully stopped.

FALSE if watchdog timer fails to stop.

C.2 WDT with DOS/Linux

Under Linux, please program WDT function using the same LPC IO registers according to the sample program as follows.

```
#include <dos.h>
#include <stddef.h>
#include <stdio.h>

/* Config LPC IO ITE8783 to enter config mode */
EnterConfig(void)
{
    outp(0x2E, 0x87);
    outp(0x2E, 0x01);
    outp(0x2E, 0x55);
    outp(0x2E, 0x55);}

/* Config LPC IO to exit config mode */
ExitConfig(void)
{
    outp(0x2E, 0x02);
    outp(0x2F, 0x02);
}

/* Read byte from LPC IO register */
unsigned char r_reg(unsigned char regoffset)
{
    outp(0x2E, regoffset);
    return inp(0x2F);
}

/* Write byte to LPC IO register */
```



```

void w_reg(unsigned char regoffset, unsigned char
data)
{
outp(0x2E, regoffset);
outp(0x2F, data);
}

main(void)
{
unsigned int    count;
/* print program title */
printf("-----MXC-2300 WDT Demo-----
----\n");
printf("Init          and          config          GPIO
ports<<<<<<<<<<<<<<<<<<<<<<<<<<<<<<\n");
printf("-----
----\n");

EnterConfig();

/* config WDT registers */
w_reg(0x07,0x07);

/* enable keyboard interrupt to reset WDT timeout
value */
w_reg(0x71,r_reg(0x71)|0x20);

/* set unit as second */
w_reg(0x72,r_reg(0x72)|0x80);

/* enable reset when timeout */
w_reg(0x72,r_reg(0x72)|0x40);

```

```
/* set timeout value as 10 seconds */
/* WDT start automatically while timeout value is set
*/
w_reg(0x73,0x0A);

printf("-----\n");
printf("WDT is set and counting down
now.<<<<<<<<<<<<<<<<<<<<<<<<<<<<<<<<<<<<<<<<<<<<<<<<<<\n");
printf("-----\n");

for(count=10;count!=0;count--)
{
printf("Countdown %2d : 0xF6=%2x Press any key to
invoke keyboard interrupt.\n",count,r_reg(0xF6));
/* reset WDT timeout value to 10 seconds */
/* w_reg(0x73,0x0A); */
        sleep(1);
}

printf("At least one keyboard interrupt must occur
during countdown.\n");
printf("Otherwise WDT has already reset system.\n\n");
printf("Try again and leave keyboard.\n\n");

/* disable WDT */
/* WDT stop while timeout value is set to zero */
        w_reg(0x73,0x00);
printf("WDT is disable. Program is terminating.");

ExitConfig();

return 0;
}
```

Appendix D Digital Input/Output Function Library

ADMX_DIO_Init

Reserves system resources for digital input/output API service. Must be called before using other MXC-2300 `matrix_dio` functions.

Syntax

C/C++, Linux C/C++, and Borland C++

```
I16 ADMX_DIO_Init(void)
```

Visual Basic

```
ADMX_DIO_Init () As Integer
```

Parameter(s)

None

Return codes

```
NoError  
ErrorOpenDriverFailed  
ErrorDeviceIoctl
```

ADMX_DIO_Close

Instructs the MXC-2300 `matrix_dio` library that DI/O is currently idle and may be released. Required at the end of a program to release all system resources.

Syntax

C/C++, Linux C/C++, and Borland C++

```
I16 ADMX_DIO_Close(void)
```

Visual Basic

```
ADMX_DIO_Close () As Integer
```

Parameter(s)

None

Return codes

NoError

DI_ReadPort

Reads digital data from the specified digital input port.

Syntax

C/C++ and Borland C++

```
I16 DI_ReadPort (U32 *Value)
```

Visual Basic

```
DI_ReadPort (Value As Long) As Integer
```

Parameter(s)

Value

Returns the digital data read from the specified port

Valid values include MXC-2300 16-bit data

Return codes

NoError

CardNotRegistered

ErrorInvalidCardNumber

ErrorCardNotRegistered

ErrorFuncNotSupport

DO_WritePort

Writes digital data to the specified digital output port.

Syntax

C/C++ and Borland C++

```
I16 DO_WritePort (U32 Value)
```

Visual Basic

```
DO_WritePort (ByVal Value As Long) As Integer
```

Parameter(s)

Value

Digital data written to the specified port

Valid values include: MXC-2300 16-bit data

Return codes

```
NoError
ErrorInvalidCardNumber
ErrorCardNotRegistered
ErrorFuncNotSupport
ErrorInvalidIoChannel
```

DO_ReadPort

Reads back digital data output from the specified digital output port.

Syntax

C/C++ and Borland C++

```
I16 DO_ReadPort (U32 *Value)
```

Visual Basic

```
DO_ReadPort (Value As Long) As Integer
```

Parameter(s)

Value

Returns the digital data read from the specified output port.

Valid values include: MXC-2300 16-bit data

Return codes

```
NoError
ErrorInvalidCardNumber
ErrorCardNotRegistered
ErrorFuncNotSupport
ErrorInvalidIoChannel
```

DI_ReadLine

Reads the digital logic state of the digital line in the specified port.

Syntax

C/C++ and Borland C++

```
I16 DI_ReadLine (U16 Line, U16 *State)
```

Visual Basic

```
DI_ReadLine (ByVal Line As Integer, State As  
Integer) As Integer
```

Parameter(s)

Line

Digital line to be read.

Valid values include: MXC-2300 0 to 15

State

Returns the digital logic state of the specified line to 0 or 1

Return codes

```
NoError  
ErrorInvalidCardNumber  
ErrorCardNotRegistered  
ErrorFuncNotSupport  
ErrorInvalidIoChannel
```

DO_WriteLine

Sets the specified digital output line in the specified digital port to the specified state. Only available for cards supporting DO readback.

Syntax

C/C++ and Borland C++

```
I16 DO_WriteLine (U16 Line, U16 State)
```

Visual Basic

```
DO_WriteLine(ByVal Line As Integer, ByVal State  
As Integer) As Integer
```

Parameter(s)

Line

Digital line to be read.

Valid values include: MXC-2300 0 to 15

State

New digital logic state 0 or 1.

Return codes

```
NoError
```

```
ErrorInvalidCardNumber
ErrorCardNotRegistered
ErrorFuncNotSupport
ErrorInvalidIoChannel
```

DO_ReadLine

Reads back the digital logic state of the specified digital output line of the specified port.

Syntax

C/C++ and Borland C++

```
I16 DO_ReadLine (U16 Line, U16 *State)
```

Visual Basic

```
DO_ReadLine (ByVal Line As Integer, State As
             Integer) As Integer
```

Parameter(s)

Line

Digital line to be read.

Valid values include: MXC-2300 0 to 15

State

Returns the digital logic state, 0 or 1, of the specified line

Return codes

```
NoError
ErrorInvalidCardNumber
ErrorCardNotRegistered
ErrorFuncNotSupport
ErrorInvalidIoChannel
```

DIO_INT_Event_Message

Controls and notifies user application when a specified interrupt event occurs. Notification is implemented through a user-specified callback function or the Windows PostMessage API. When a new event message is added, it remains active until the function is called by setting the argument mode to 0, removing the specified interrupt event message. To remove a

specified message, the event handle for the message must be identified.

Syntax

C/C++ and Borland C++

```
I16 DIO_INT_EventMessage (I16 mode, HANDLE evt,  
HANDLE windowHandle, U32 message, U32  
callbackAddr)
```

Visual Basic

```
DIO_INT_EventMessage (ByVal mode As Integer,  
ByVal evt As Long, ByVal windowHandle As  
Long, ByVal message As Long, ByVal  
callbackAddr As Long) As Integer
```

Parameter(s)

mode

Operation mode of adding or removing message, with
0 Removes an existing message interrupt event defined argu-
ment event

1 Adds a new message for an interrupt event defined

evt

Handle of the INT event to be handled.

windowHandle

Handle to the destination window for a Windows message when the specified INT event occurs. If windowHandle is 0, no Windows messages will be sent.

message

User-defined message. When the specified INT event occurs, MXC-2300 matrix_dio remits this message. The message can be of any value. In Windows, the message can be set to a value including any Windows predefined messages, such as WM_PAINT. However, to define a designated message, any value ranging from WM_USER (0x400) to 0x7fff can be used. This range is reserved by Windows for user-defined messages.

callbackAddr

Address of the user callback function. The MXC-2300 `matrix_dio` calls this function when the specified INT event occurs. If no callback function is desired, set `callbackAddr` to 0.

Return codes

```
NoError
ErrorInvalidCardNumber
ErrorCardNotRegistered
ErrorFuncNotSupport
```

DIO_INT1_EventMessage

Controls the INT1 interrupt sources for a dual-interrupt system and notifies the application when an interrupt event occurs. Notification is implemented through a user-specified callback function or the Windows `PostMessage` API.

Syntax

C/C++ and Borland C++

```
I16 DIO_INT1_EventMessage (I16 Int1Mode, HANDLE
    windowHandle, U32 message, void
    *callbackAddr())
```

Visual Basic

```
DIO_INT1_EventMessage (ByVal Int1Mode As Integer,
    ByVal windowHandle As Long, ByVal message As
    Long, ByVal callbackAddr As Long) As Integer
```

Parameter(s)

Int1Mode

Interrupt mode of INT1.

Valid values include: MXC-2300, INT1_DISABLE, INT1_EXT_SIGNAL INT1 by COS of Ch0 of Port 0

windowHandle

Handle to the destination window for a Windows message when the specified INT event occurs. If `windowHandle` is 0, no Windows messages will be sent.

message

User-defined message. When the specified INT event occurs, MXC-2300 matrix_dio remits this message. The message can be of any value. In Windows, the message can be set to a value including any Windows predefined messages, such as WM_PAINT. However, to define a designated message, any value ranging from WM_USER (0x400) to 0x7fff can be used. This range is reserved by Windows for user-defined messages.

callbackAddr

Address of the user callback function. The MXC-2300 matrix_dio calls this function when the specified INT event occurs. If no callback function is desired, set callbackAddr to 0.

Return codes

```
NoError  
ErrorInvalidCardNumber  
ErrorCardNotRegistered  
ErrorFuncNotSupport
```

DIO_INT2_EventMessage

Controls INT2 interrupt sources for a dual-interrupt system and notifies the application when an interrupt event occurs. The notification is performed through a user-specified callback function or the Windows PostMessage API.

Syntax

C/C++ and Borland C++

```
I16 DIO_INT2_EventMessage (I16 Int2Mode, HANDLE  
    windowHandle, U32 message, void  
    *callbackAddr())
```

Visual Basic

```
DIO_INT2_EventMessage (ByVal Int2Mode As Integer,  
    ByVal windowHandle As Long, ByVal message As  
    Long, ByVal callbackAddr As Long) As Integer
```

Parameter(s)

Int2Mode

INT2 interrupt mode. Valid values include: MXC-2300, INT2_DISABLE, and INT2_EXT_SIGNAL INT2 by COS of Ch1 of Port 0

windowHandle

Handle to the destination window for a Windows message when the specified INT event occurs. If windowHandle is 0, no Windows messages will be sent.

message

User-defined message. When the specified INT event occurs, MXC-2300 matrix_dio remits this message. The message can be of any value. In Windows, the message can be set to a value including any Windows predefined messages, such as WM_PAINT. However, to define a designated message, any value ranging from WM_USER (0x400) to 0x7fff can be used. This range is reserved by Windows for user-defined messages.

callbackAddr

Address of the user callback function. The MXC-2300 matrix_dio calls this function when the specified INT event occurs. If no callback function is desired, set callbackAddr to 0.

Return codes

```
NoError
ErrorInvalidCardNumber
ErrorCardNotRegistered
ErrorFuncNotSupport
```

DIO_SetDualInterrupt

Informs the MXC-2300 matrix_dio library of the two interrupt source modes of a dual-interrupt system and returns dual interrupt events. If an interrupt is generated, the corresponding interrupt event is signaled. The application uses Win32 wait functions, such as WaitForSingleObject or WaitForMultipleObjects to determine interrupt event status.

Syntax

C/C++ and Borland C++

```
I16 DIO_SetDualInterrupt (I16 Int1Mode, I16
    Int2Mode, HANDLE *hEvent)
```

Visual Basic

```
DIO_SetDualInterrupt (ByVal Int1Mode As Integer,  
    ByVal Int2Mode As Integer, hEvent As Long)  
    As Integer
```

Parameter(s)

CardNumber

ID of the card performing the operation.

Int1Mode

Interrupt mode of INT1.

Valid values include: MXC-2300, and INT1_DISABLE, INT1_EXT_SIGNAL INT1 by COS of Ch0 of Port 0

Int2Mode

Interrupt mode of INT2.

Valid values include: MXC-2300, and INT2_DISABLE, INT2_EXT_SIGNAL INT2 by COS of Ch1 of Port 0

hEvent

Returned dual-interrupt event handles, where status of a dual-interrupt event indicates whether an interrupt is generated for cards comprising dual-interrupt systems

Return codes

```
NoError  
ErrorInvalidCardNumber  
ErrorCardNotRegistered  
ErrorFuncNotSupport
```

Important Safety Instructions

For user safety, please read and follow all **instructions**, **WARNINGS**, **CAUTIONS**, and **NOTES** marked in this manual and on the associated equipment before handling/operating the equipment.

- ▶ Read these safety instructions carefully.
- ▶ Keep this user's manual for future reference.
- ▶ Read the specifications section of this manual for detailed information on the operating environment of this equipment.
- ▶ When installing/mounting or uninstalling/removing equipment:
 - ▷ Turn off power and unplug any power cords/cables.
- ▶ To avoid electrical shock and/or damage to equipment:
 - ▷ Keep equipment away from water or liquid sources;
 - ▷ Keep equipment away from high heat or high humidity;
 - ▷ Keep equipment properly ventilated (do not block or cover ventilation openings);
 - ▷ Make sure to use recommended voltage and power source settings;
 - ▷ Always install and operate equipment near an easily accessible electrical socket-outlet;
 - ▷ Secure the power cord (do not place any object on/over the power cord);
 - ▷ Only install/attach and operate equipment on stable surfaces and/or recommended mountings; and,
 - ▷ If the equipment will not be used for long periods of time, turn off and unplug the equipment from its power source.

- ▶ Never attempt to fix the equipment. Equipment should only be serviced by qualified personnel.

A Lithium-type battery may be provided for uninterrupted, backup or emergency power.



There is risk of explosion if the battery is replaced with an incorrect type. Dispose of used batteries appropriately.

-
- ▶ Equipment must be serviced by authorized technicians when:
 - ▷ The power cord or plug is damaged;
 - ▷ Liquid has penetrated the equipment;
 - ▷ It has been exposed to high humidity/moisture;
 - ▷ It is not functioning or does not function according to the user's manual;
 - ▷ It has been dropped and/or damaged; and/or,
 - ▷ It has an obvious sign of breakage.

Getting Service

Contact us should you require any service or assistance.

ADLINK Technology, Inc.

Address: 9F, No.166 Jian Yi Road, Zhonghe District
New Taipei City 235, Taiwan
新北市中和區建一路 166 號 9 樓
Tel: +886-2-8226-5877
Fax: +886-2-8226-5717
Email: service@adlinktech.com

Ampro ADLINK Technology, Inc.

Address: 5215 Hellyer Avenue, #110
San Jose, CA 95138, USA
Tel: +1-408-360-0200
Toll Free: +1-800-966-5200 (USA only)
Fax: +1-408-360-0222
Email: info@adlinktech.com

ADLINK Technology (China) Co., Ltd.

Address: 上海市浦东新区张江高科技园区芳春路 300 号 (201203)
300 Fang Chun Rd., Zhangjiang Hi-Tech Park
Pudong New Area, Shanghai, 201203 China
Tel: +86-21-5132-8988
Fax: +86-21-5132-3588
Email: market@adlinktech.com

ADLINK Technology Beijing

Address: 北京市海淀区上地东路 1 号盈创动力大厦 E 座 801 室(100085)
Rm. 801, Power Creative E, No. 1 Shang Di East Rd.
Beijing, 100085 China
Tel: +86-10-5885-8666
Fax: +86-10-5885-8626
Email: market@adlinktech.com

ADLINK Technology Shenzhen

Address: 深圳市南山区科技园南区高新南七道 数字技术园
A1 栋 2 楼 C 区 (518057)
2F, C Block, Bldg. A1, Cyber-Tech Zone, Gao Xin Ave. Sec. 7
High-Tech Industrial Park S., Shenzhen, 518054 China
Tel: +86-755-2643-4858
Fax: +86-755-2664-6353
Email: market@adlinktech.com

LiPPERT ADLINK Technology GmbH

Address: Hans-Thoma-Strasse 11, D-68163
Mannheim, Germany
Tel: +49-621-43214-0
Fax: +49-621 43214-30
Email: emea@adlinktech.com

ADLINK Technology, Inc. (French Liaison Office)

Address: 6 allée de Londres, Immeuble Ceylan
91940 Les Ulis, France
Tel: +33 (0) 1 60 12 35 66
Fax: +33 (0) 1 60 12 35 66
Email: france@adlinktech.com

ADLINK Technology Japan Corporation

Address: 〒101-0045 東京都千代田区神田鍛冶町 3-7-4
神田 374 ビル 4F
KANDA374 Bldg. 4F, 3-7-4 Kanda Kajicho,
Chiyoda-ku, Tokyo 101-0045, Japan
Tel: +81-3-4455-3722
Fax: +81-3-5209-6013
Email: japan@adlinktech.com

ADLINK Technology, Inc. (Korean Liaison Office)

Address: 137-881 서울시 서초구 서초대로 326, 802 (서초동, 모인터빌딩)
802, Mointer B/D, 326 Seocho-daero, Seocho-Gu,
Seoul 137-881, Korea
Tel: +82-2-2057-0565
Fax: +82-2-2057-0563
Email: korea@adlinktech.com

ADLINK Technology Singapore Pte. Ltd.

Address: 84 Genting Lane #07-02A, Cityneon Design Centre
Singapore 349584
Tel: +65-6844-2261
Fax: +65-6844-2263
Email: singapore@adlinktech.com

ADLINK Technology Singapore Pte. Ltd. (Indian Liaison Office)

Address: #50-56, First Floor, Spearhead Towers
Margosa Main Road (between 16th/17th Cross)
Malleswaram, Bangalore - 560 055, India
Tel: +91-80-65605817, +91-80-42246107
Fax: +91-80-23464606
Email: india@adlinktech.com

ADLINK Technology, Inc. (Israeli Liaison Office)

Address: 27 Maskit St., Corex Building
PO Box 12777
Herzliya 4673300, Israel
Tel: +972-54-632-5251
Fax: +972-77-208-0230
Email: israel@adlinktech.com

ADLINK Technology, Inc. (UK Liaison Office)

Tel: +44 774 010 59 65
Email: UK@adlinktech.com